

CABO D

RESORT EXTRUSIONS
PRODUCT CODE: CABO-D



On frame On graphic



PRODUCT DESCRIPTION

The Cabo aluminum extrusion profile system is an elegant and versatile solution for all of your display needs. Featuring a sleek silver anodized finish, the Cabo is the perfect solution for tradeshow booths, retail environments, pop up shops, or any place aluminum framing is needed. The profiles are available in standard 40mm and 80mm profile widths and in different shapes allowing you to turn your display vision into reality. Promote your company, new products, etc with custom dye sublimated fabric graphics. 12mm x 3mm silicone beading (SEG) is sewn around the perimeter of each fabric panel for easy installation and removal of your graphics. Choose from one of our pre designed configurations or contact us for a quote on something totally custom.

DISPLAY DIMENSIONS	354" W x 172.2"H x 239.8"D
GRAPHIC SIZE	See Template Page

GRAPHIC MATERIAL

Dye-Sub Black & White Fabric

GRAPHIC FINISHING

12mm x 3mm silicone beading is sewn around the perimeter of the fabric graphic. Silicone beading is hidden from view once installed.

DISPLAY CONSTRUCTION

Extruded aluminum profile frame with aluminum and steel components

SHIPPING WEIGHTS & DIMENSIONS

Shipping Weight	775 lbs (frame only) - LTL ONLY
	810 lbs (frame & graphic) - LTL ONLY
	35 lbs (graphic only) - UPS
Shipping Dimensions	102"L x 49.5"W x 44.5"H (Graphic Package & Hardware Only)

GRAPHIC TURN AROUND TIME

5 business days after proof approval for up to 2 booths

AVAILABILITY	PFC
--------------	-----

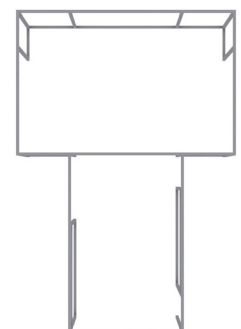
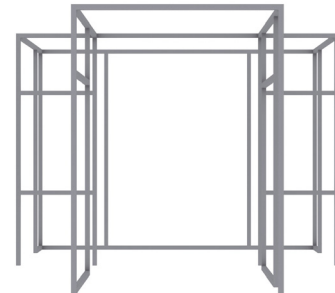
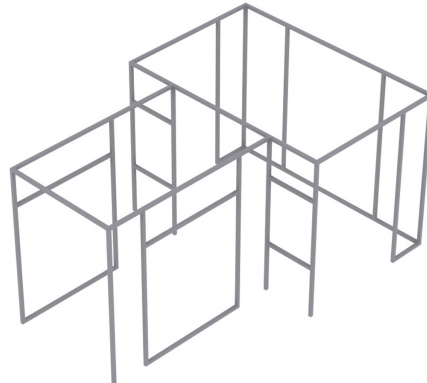
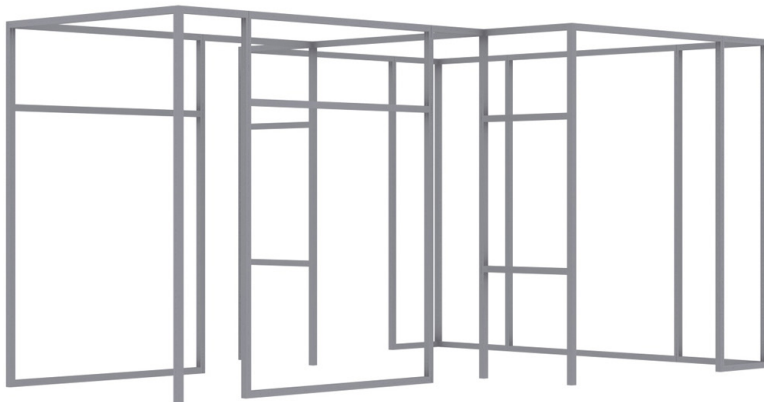

PARTS LIST HARDWARE ONLY

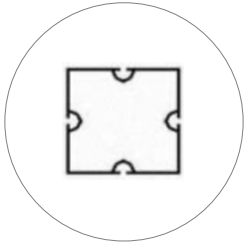

CABO-80 86.1" W
(qty 30)

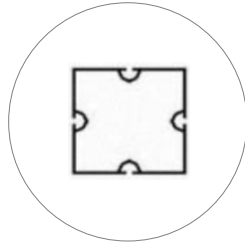

CABO-80 76.4" W
(qty 8)

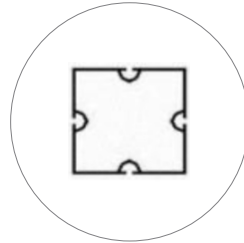

CABO-80 56.9" W
(qty 16)

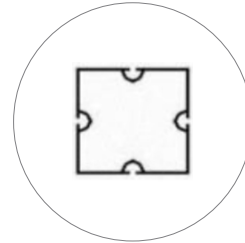

CABO-80 74.8" W
(qty 1)

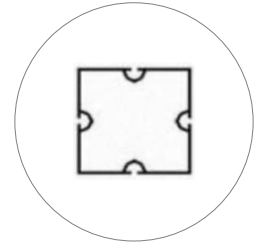

CABO-80 35.8" W
(qty 16)

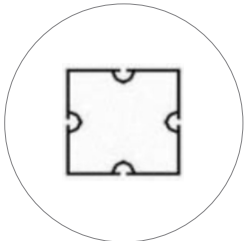

CABO-80 60" W
(qty 4)

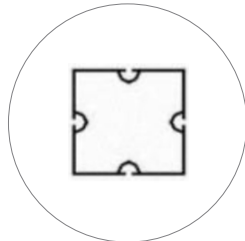

CABO-80 53.6" W
(qty)

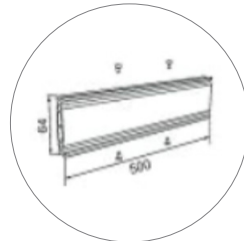

CABO-80 ADPT
(qty 27)

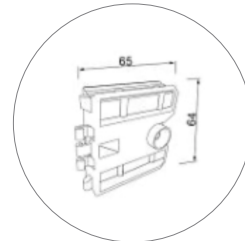

CABO-80-LOCK
(qty 60)

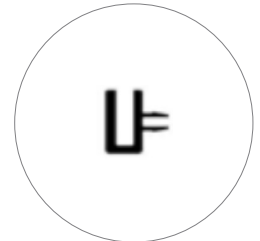

CABO-SEG-PLASTIC 60" W
(qty 4)

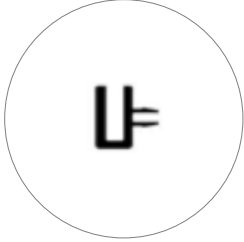

CABO-SEG-PLASTIC 82.95" W
(qty 12)

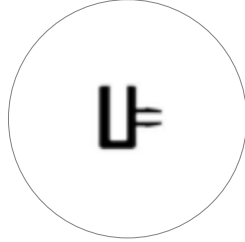

CABO-SEG-PLASTIC 53.6" W
(qty 4)

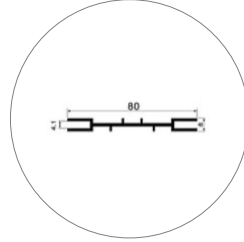

CABO-SEG-PLASTIC 35.7" W
(qty 8)

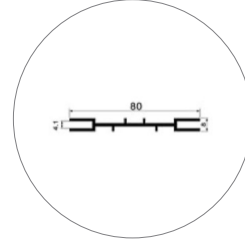

CABO-SEG-PLASTIC 70.8" W
(qty 4)

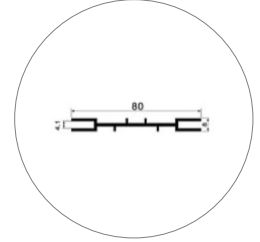

CABO-SEG-PLASTIC 53.6" W
(qty 8)

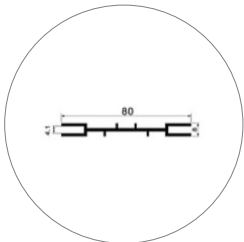

CABO-SEG-PLASTIC 63.45" W
(qty 8)

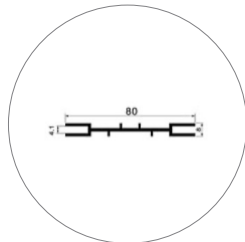

CABO-SEG-PLASTIC 82.95" W
(qty 8)

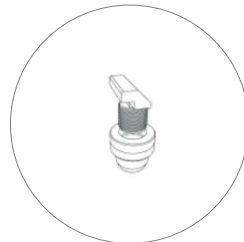

CABO-HHS
(qty 139)

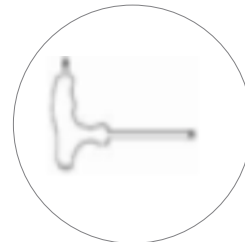

CABO-TTORX
(qty 1)



CABO-LTORX
(qty 1)



CABO-TSCREWDRIVER
(qty 1)

Template Guide

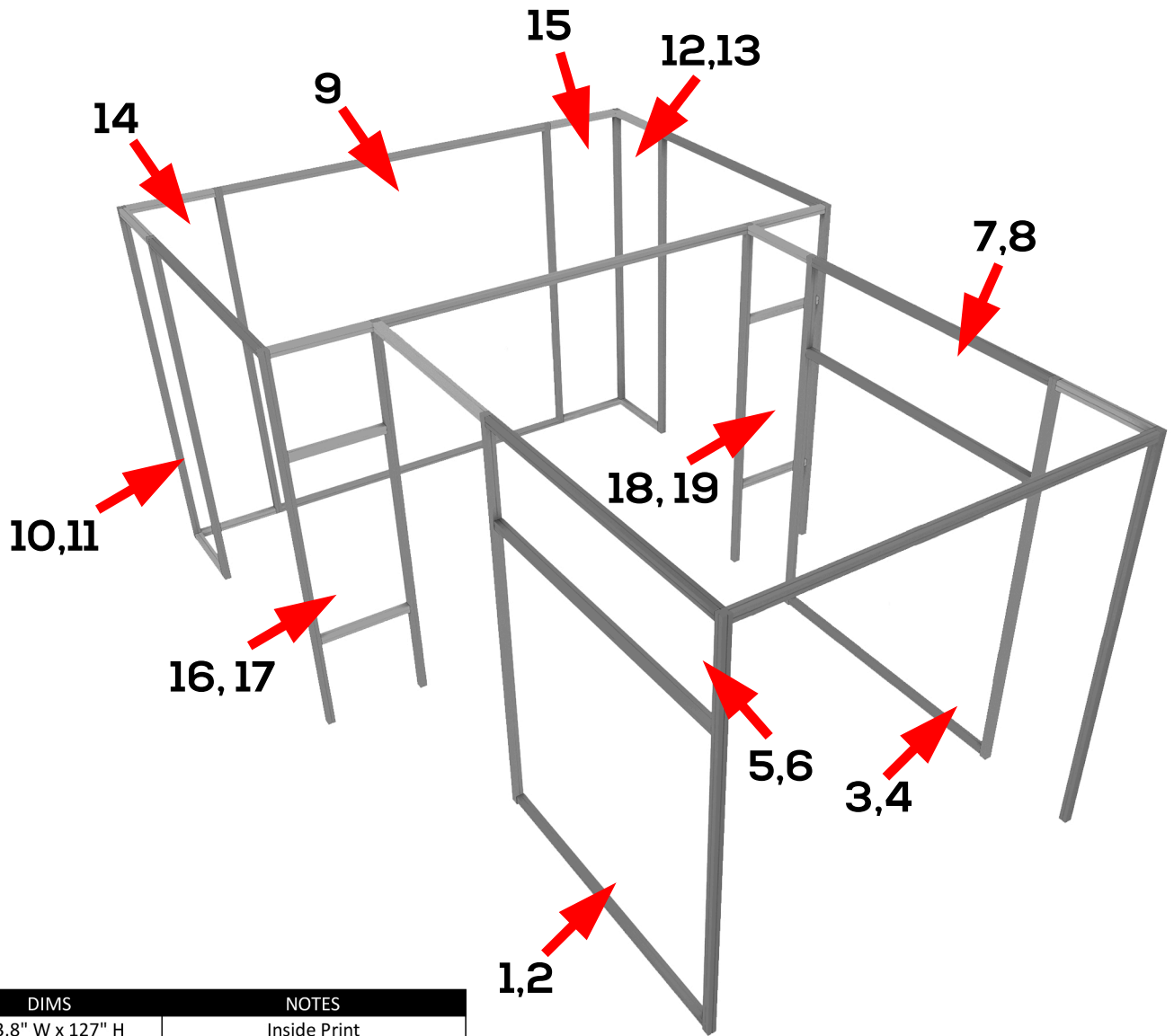

Panel	DIMS	NOTES
1	113.8" W x 127" H	Inside Print
2	113.8" W x 127" H	Outside Print
3	113.8" W x 127" H	Inside Print
4	113.8" W x 127" H	Outside Print
5	113.8" W x 35.8" H	Inside Print
6	113.8" W x 35.8" H	Outside Print
7	113.8" W x 35.8" H	Inside Print
8	113.8" W x 35.8" H	Outside Print
9	120" W x 166" H	Inside Print
10	35.8" W x 166" H	Inside Print
11	35.8" W x 166" H	Outside Print
12	35.8" W x 166" H	Inside Print
13	35.8" W x 166" H	Outside Print
14	53.6" W x 166" H	Inside Print
15	53.6" W x 166" H	Inside Print
16	53.6" W x 70.9" H	Inside Print
17	53.6" W x 70.9" H	Outside Print
18	53.6" W x 70.9" H	Inside Print
19	53.6" W x 70.9" H	Outside Print

Frame Assembly

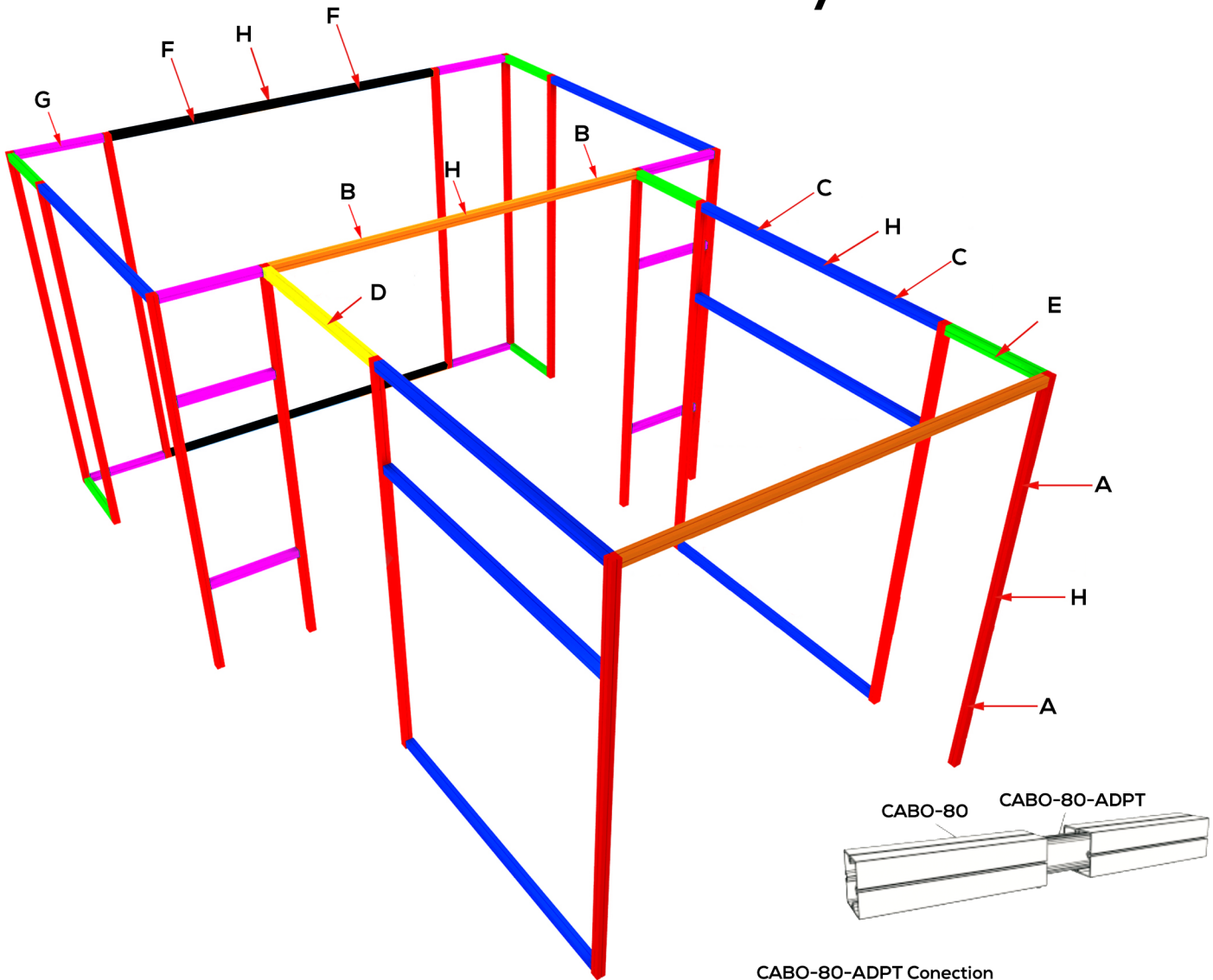

CABO-80-ADPT Connection

1. Insert CABO-80-ADPT into one CABO-80 profile
2. Slide opposing CABO-80 profile onto CABO-80-ADPT
3. Tighten screws on CABO-80-ADPT to secure profiles in place

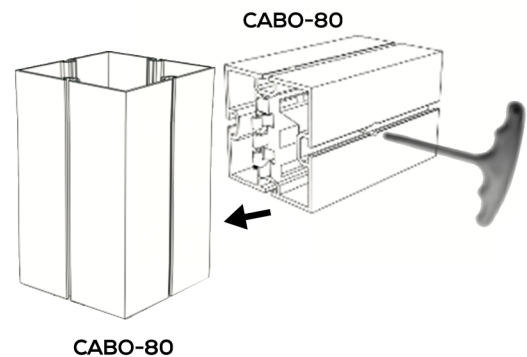

CABO 80 Profile Connection

1. Line up lock with system groove on vertical profile
2. Insert teeth of lock into groove
3. Use torx tool to tighten lock (turn clockwise to tighten)

REF	SKU	QTY	LENGTH IN
A	CABO-80	30	86.1"
B	CABO-80	4	76.4"
C	CABO-80	16	56.9"
D	CABO-80	1	74.8"
E	CABO-80	6	35.8"
F	CABO-80	4	60"
G	CABO-80	6	53.6"
H	CABO-80-ADPT	27	n/a

SEG Attachments

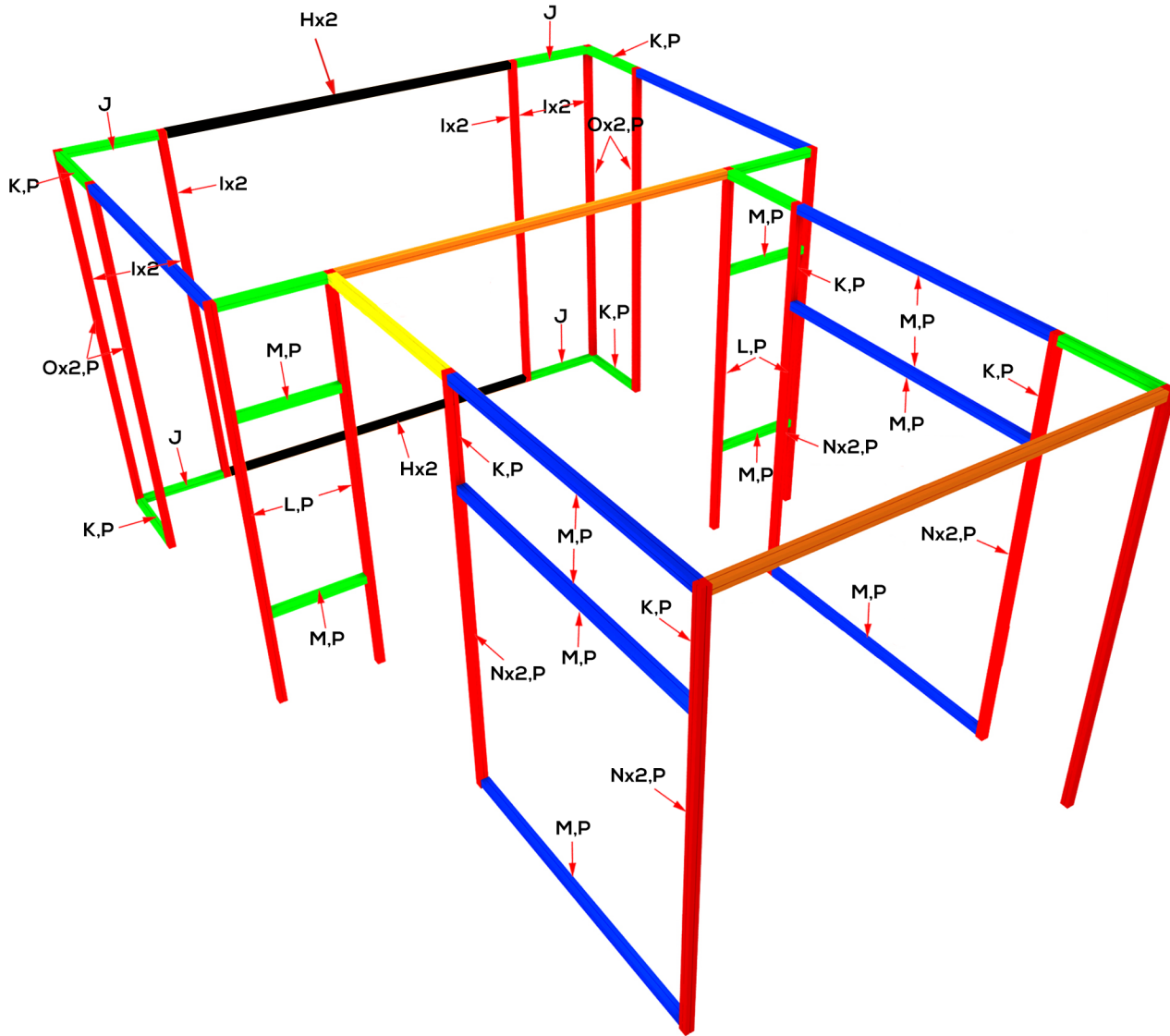

REF	SKU	QTY	LENGTH IN
H	CABO-SEG-PLASTIC	4	60"
I	CABO-SEG-PLASTIC	12	82.95
J	CABO-SEG-PLASTIC	4	53.6"
K	CABO-80-SEG	8	35.7"
L	CABO-80-SEG	4	70.8"
M	CABO-80-SEG	8	53.6"
N	CABO-80-SEG	8	63.45"
O	CABO-80-SEG	8	82.95
P	CABO-HHS	139	165.9"

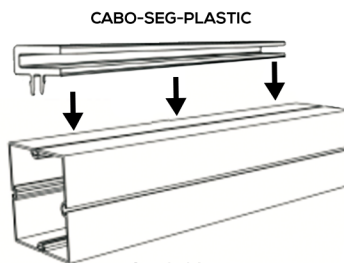

CABO-SEG-PLASTIC Installation
 1. Line up clip of CABO-SEG-PLASTIC with system groove of profile
 2. Press CABO-SEG-PLASTIC down to lock into place.

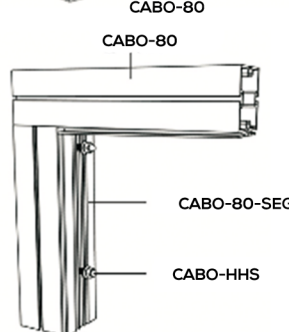

CABO-80-SEG Installation
 1. Unscrew CABO-HHS and feed through holes on CABO-80-SEG
 2. Line up CABO-HHS with system groove on profile CABO-80-SEG will attach to
 3. Tighten CABO-HHS clockwise to secure