

Formulate 10' Four Sided Tower

COL-02

Mix and match the Formulate® line of towers to add architecture and drama to any event or interior space. Rectangular-shaped towers come in 12ft, 10ft and 8ft heights and 3ft square at the top and bottom. They combine the latest developments in fabric printed technology with aluminum tube frames to add dimension, decor and sculpture to any event, stage set, tradeshow booth or interior space. Formulate towers accommodate internal LED lighting to create a glowing effect.

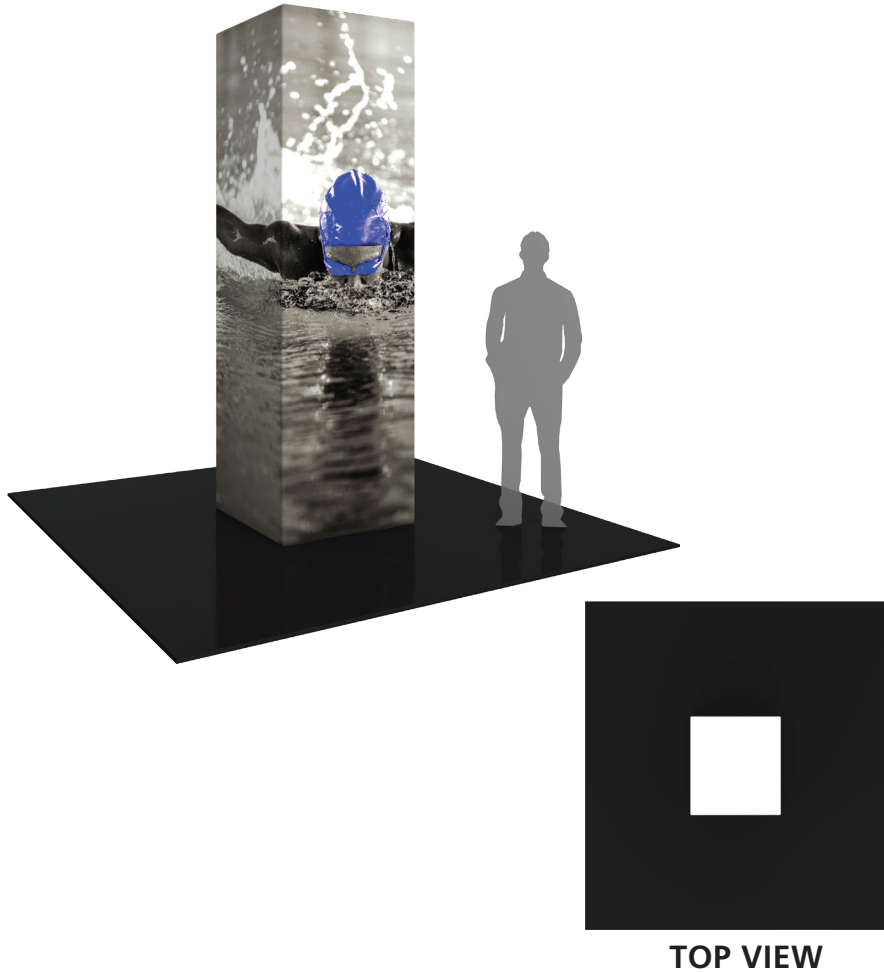

features and benefits:

- State-of-the-art 30mm aluminum tube frame with snap button assembly
- Easy to store and ship
- Quick to set up
- Kit includes: one frame, one dye-sublimated zipper pillowcase graphic, and one wheeled storage case
- Lifetime hardware warranty against manufacturer defects

dimensions:

Hardware

Graphic

Assembled unit:
36" w x 120" h x 36" d
915mm(w) x 3048mm(h) x 915mm(d)

Refer to related graphic template for more information.

Approximate weight (includes graphic):
29 lbs / 13 kg

Visit:
<https://www.theexhibitorshandbook.com/download-graphic-templates>

Shipping

additional information:

Packing case(s):
1 OCL

Graphic material:
Dye-sublimation zipper pillowcase fabric

Shipping dimensions:
OCL:
57" l x 19" h x 19" d
1448mm(l) x 483mm(h) x 483mm(d)

Approximate total shipping weight:
49 lbs / 22 kg

We are continually improving and modifying our product range and reserve the right to vary the specifications without prior notice. All dimensions and weights quoted are approximate and we accept no responsibility for variance. E&OE. See Graphic Templates for graphic bleed specifications.

Included In Your Kit

Tools, Components, & Connectors



TC-30-3W x8

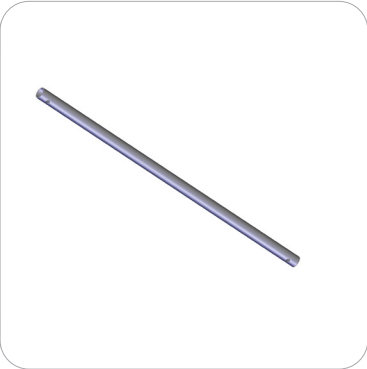

COL-02-T1 x8



COL-02-T2 x8

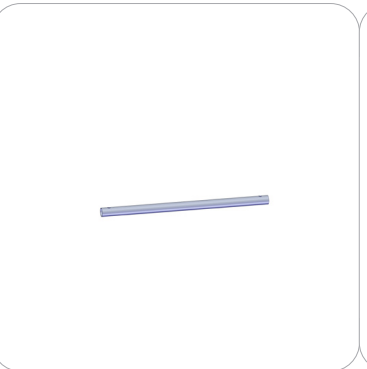

COL-02-T3 x4

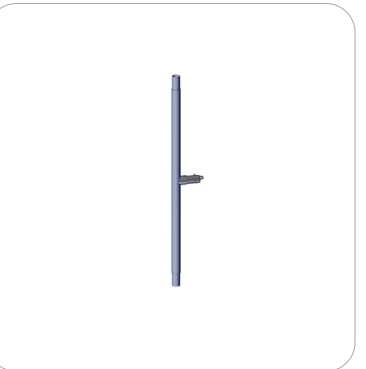

COL-02-T6 x4



TC-30-X x1

Graphics

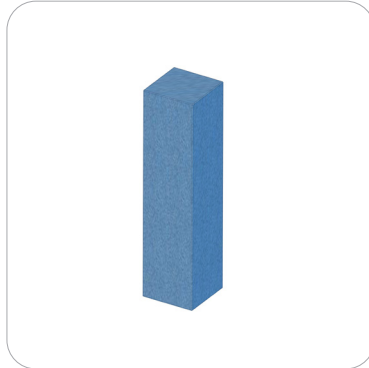

COL-02-G x1

Exploded View

COL-02

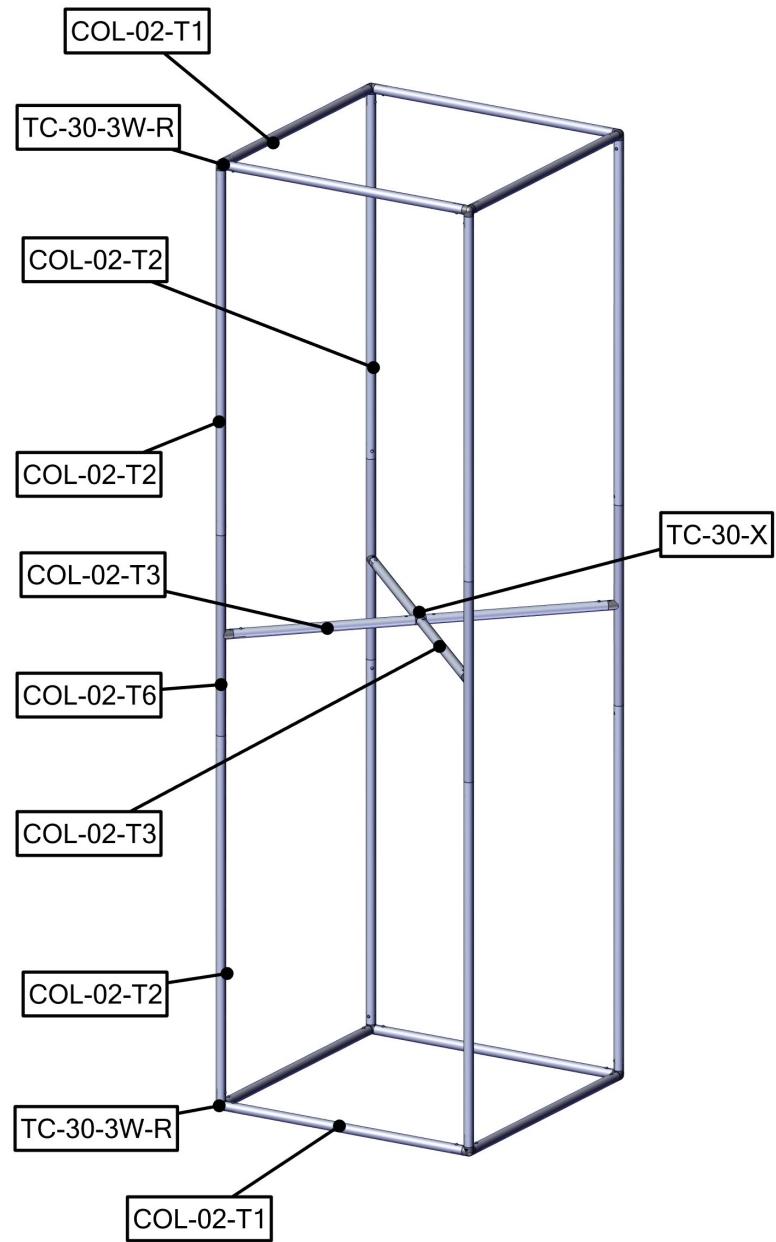

Labeling Diagram

COL-02

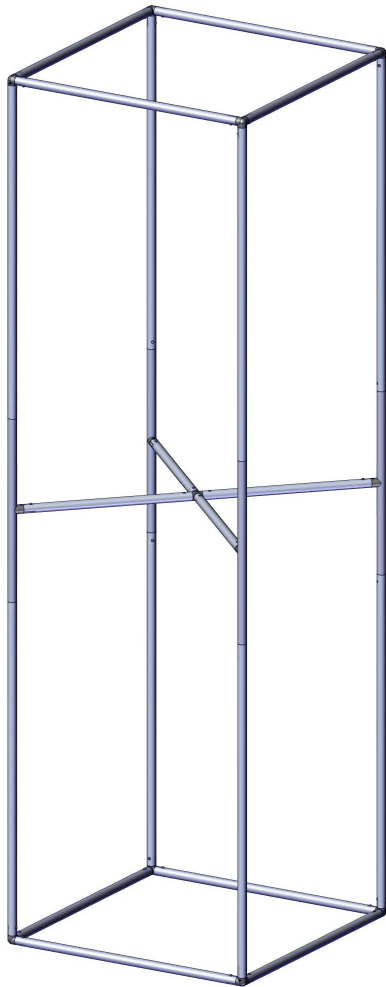

Section 1:

SECTION 1

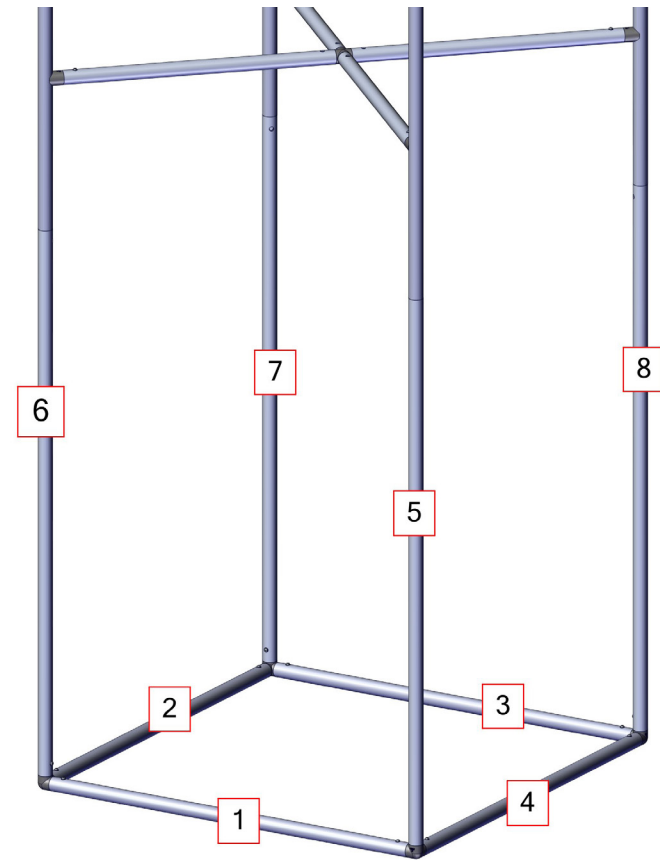

Labeling Diagram

COL-02

Section 2:

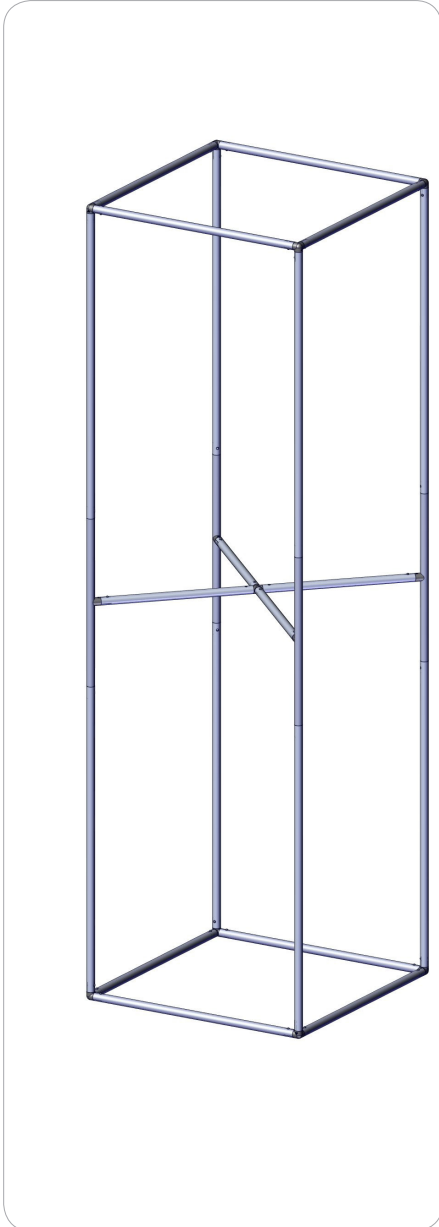

SECTION 2

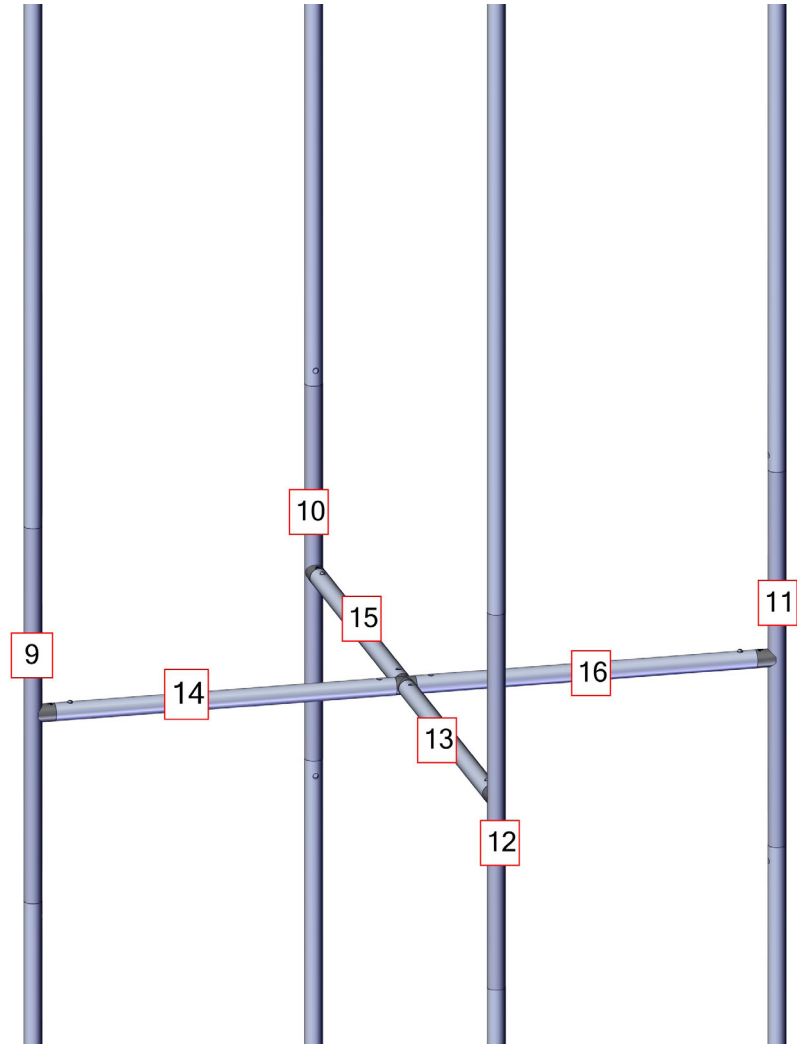

Labeling Diagram

COL-02

Section 2:

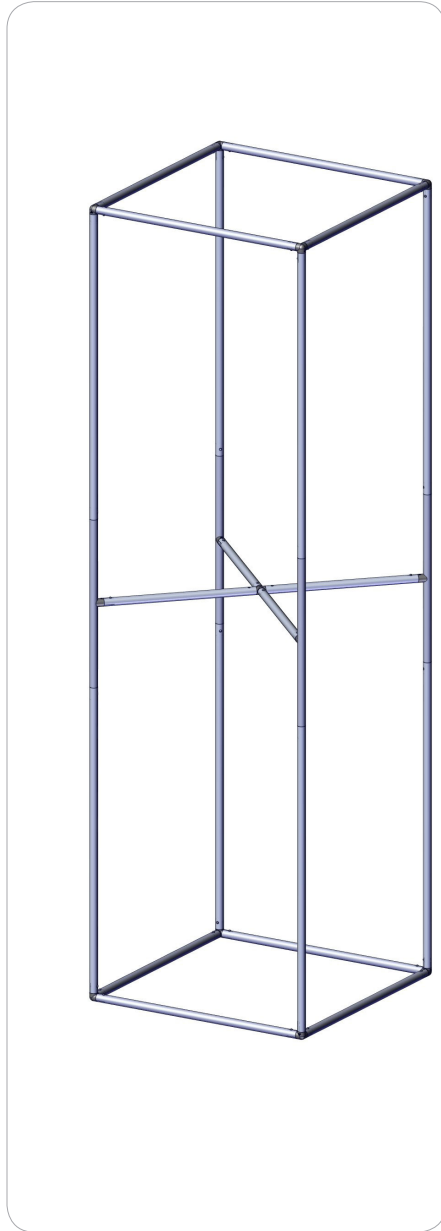

SECTION 3

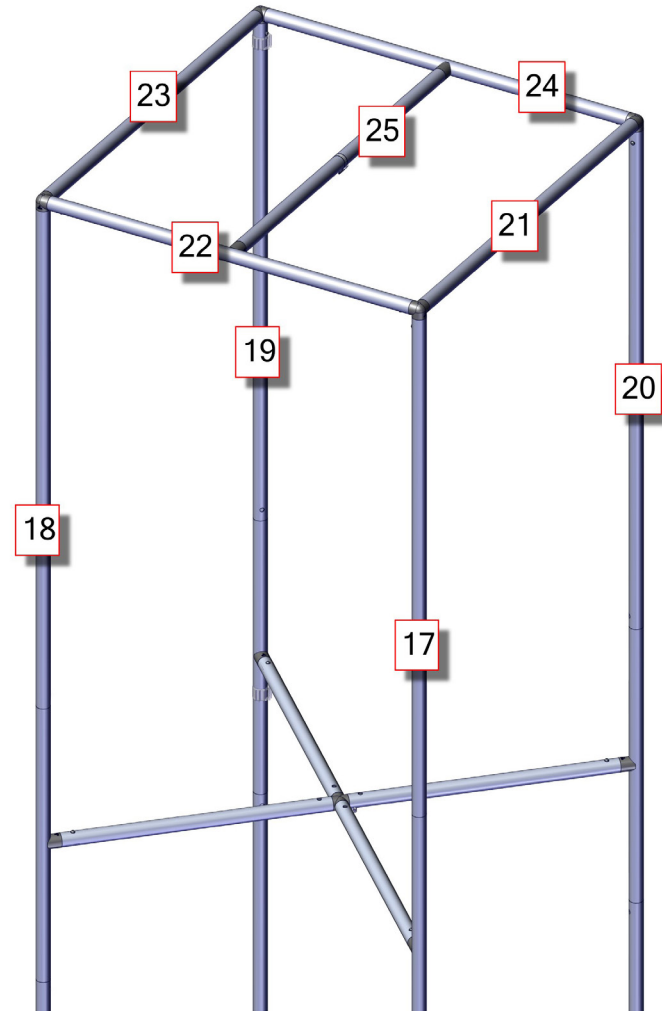

Kit Assembly

Step by Step

Step 1.

Gather the components to build Section 1 of the tower frame. Use the Exploded View and the Labeling Diagram for part labels.

Reference Connection Methods 2 for more details.

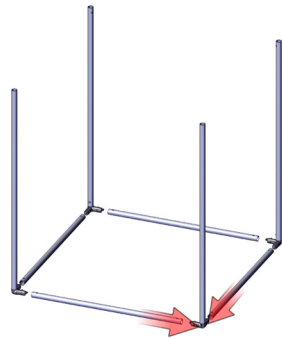

Step 2.

Gather the components to build Section 2 of the tower frame. Use the Exploded View and the Labeling Diagram for part labels.

Reference Connection Method 3 and 4 for more details.

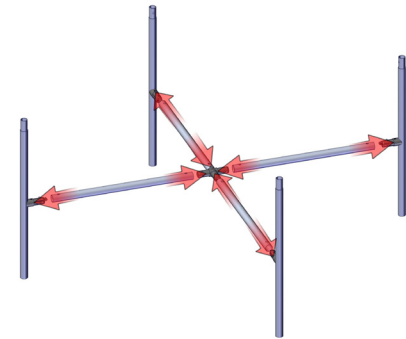
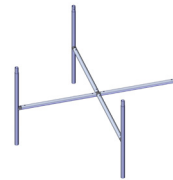

Step 3.

Gather the components to build Section 3 of the tower frame. Use the Exploded View and the Labeling Diagram for part labels.

Reference Connection Methods 2 for more details.

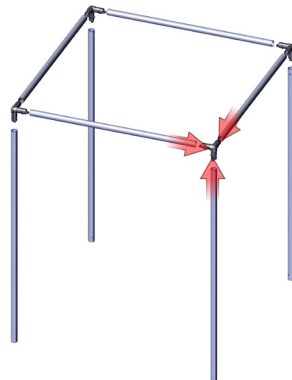
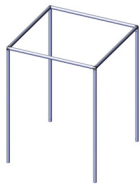

Step 4.

Lay the three sections flat on floor. Combine them to complete the tower frame assembly. Use the Exploded View and the Labeling Diagram for part labels.

Reference Connection Method 1 for more details.

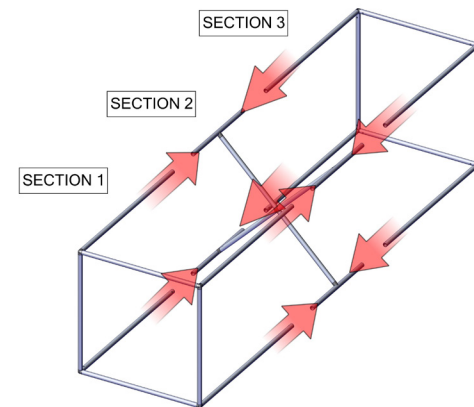
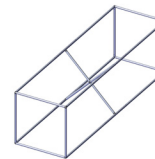

Kit Assembly

Step by Step

Step 5.

Leave the tower frame flat on floor. Undo the zipper pillow case and pull it over the top of the tower. Work the pillowcase down to the bottom of the frame carefully zip it up and then stand the frame upright.

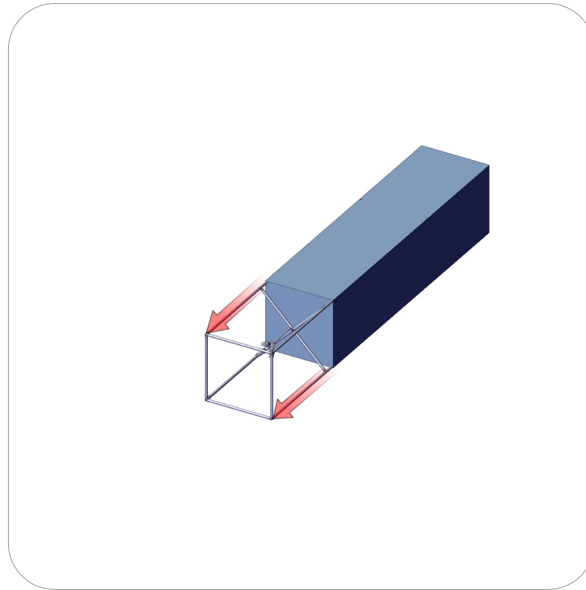
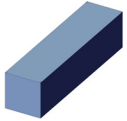

Step 6.

Setup complete

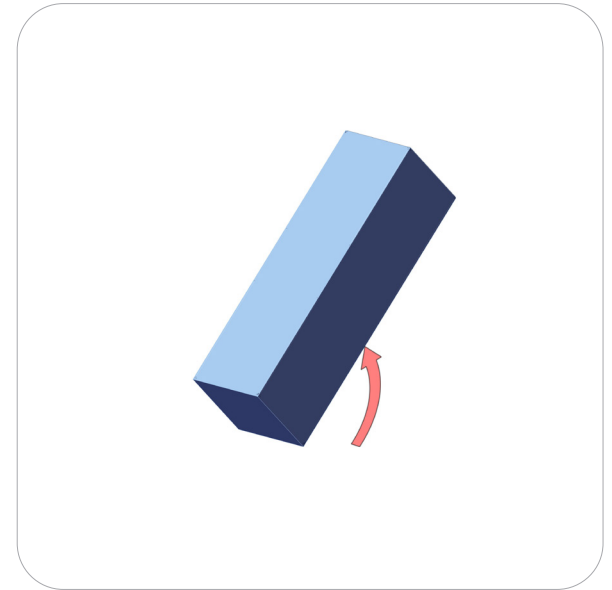

Connection Methods

Connection Method 1: SNAP BUTTONS

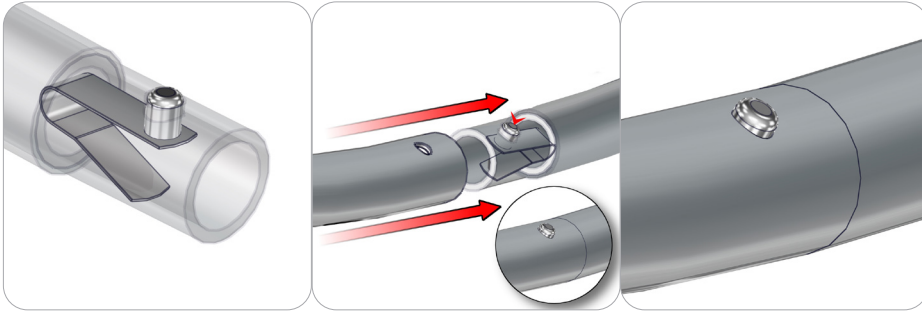

Snap button connections are simple and easy to use. First, locate the snap button on the connector or swage tube. Second, locate the hole on the corresponding tube. Press the snap button with your thumb and slide the tube and connector together so that the snap button snaps fully into the hole. To disassemble, press the snap button and carefully pull them apart.

Connection Method 2: TC-30-3W-R

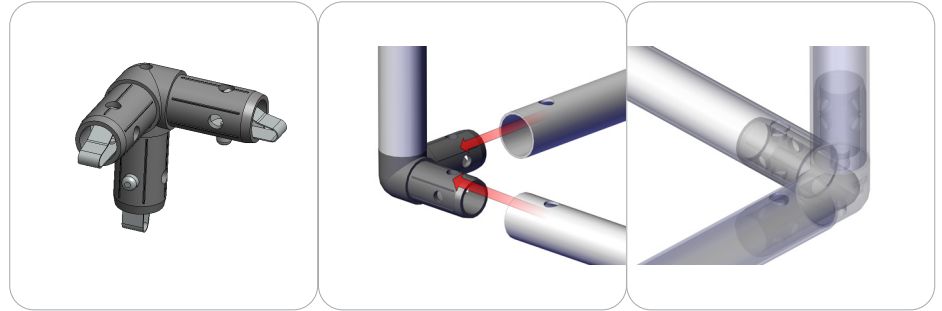

Snap button connections are simple and easy to use. First, locate the snap button on the connector or swage tube. Second, locate the hole on the corresponding tube. Press the snap button with your thumb and slide the tube and connector together so that the snap button snaps fully into the hole. To disassemble, press the snap button and carefully pull them apart.

Connection Method 3: COL-02-T3/COL-02-T6

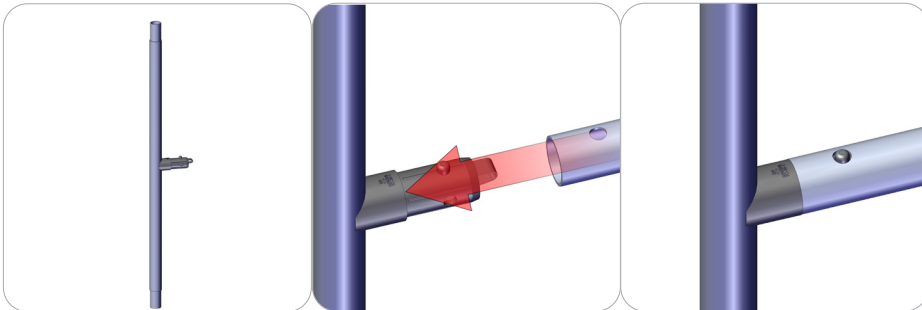

Snap button connections are simple and easy to use. First, locate the snap button on the connector or swage tube. Second, locate the hole on the corresponding tube. Press the snap button with your thumb and slide the tube and connector together so that the snap button snaps fully into the hole. To disassemble, press the snap button and carefully pull them apart.

Connection Method 4: TC-30-X

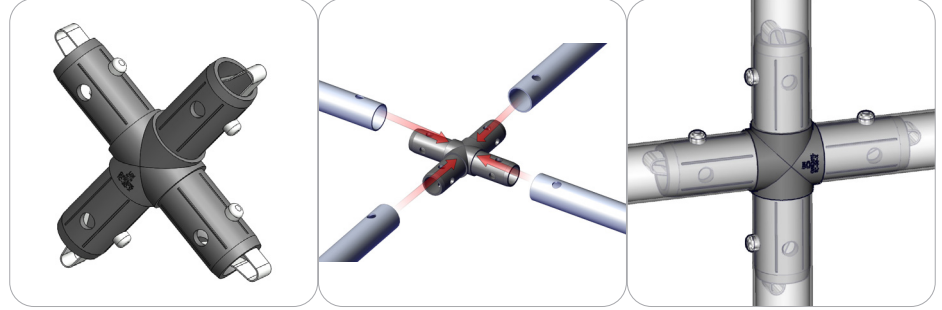

First, connect spreader tubes (COL-T3) to TC-30-X. Second, once the X frame is assembled, connect side tubes (COL-T6).