

Formulate Master 3D Hanging Structures: Cube

CUBE

Formulate® tension fabric hanging structures are made in the USA and are of the utmost quality and durability. Formulate combines state-of-the-art zipper pillowcase dye-sublimated stretch fabric coverings with advanced, lightweight aluminum structures to provide unique design, functionality, and style.



We are continually improving and modifying our product range and reserve the right to vary the specifications without prior notice. All dimensions and weights quoted are approximate and we accept no responsibility for variance. E&OE. See Graphic Templates for graphic bleed specifications.

features and benefits:

- Shapes 6' wide and under are constructed with 30mm (1.25') tubes and push button connectors for simple assembly
- Shapes 8' and over are constructed with 50mm (2") tubes and internal expanding spigot connectors for unmatched structural integrity
- Easy to store and ship
- Quick to set up
- One zipper pillowcase fabric graphic
- Lifetime limited hardware warranty against manufacturer defects
- All cube sizes are available with backlighting

dimensions:

Hardware

Assembled unit:

(3', 4', 6', 8', or 10')w x (3', 4', 6', 8', or 10')h
(.91, 1.22, 1.83, or 3.05)m(w) x (.91, 1.22, 1.83, or 3.05)m(h)

Approximate weight:

Depending on size, weight varies between:
24.71 lb / 11.21 kg - 222.44 lb / 100.9 kg

Shipping

Packing case(s):

1-4 expandable cardboard boxes depending on size

Shipping dimensions:

Expandable cardboard box length (l) may vary
45-98"l x 16"h x 16"d
1143-2489.2mm(l) x 406.4mm(h) x 406.4mm(d)

Approximate total shipping weight

(includes cases & graphics):
Depending on size, weight varies between:
29.21 lb / 13.25 kg - 274.19 lb / 124.27 kg

Graphic

Refer to related graphic template for more information.

Visit:

www.exhibitors-handbook.com/graphic-templates

additional information:

Graphic material:

dye-sublimation zipper pillowcase fabric

Included In Your Kit

Tools, Components & Connectors



EYEBOLT x4

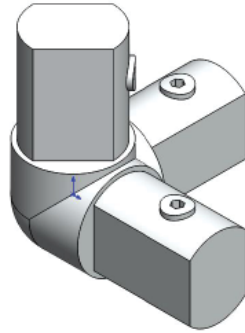

ES50-3W x8



ES50 x16



ES30 x1



WC-30T x2

Tubes



CUBE-1010-T1-BL x20



CUBE-1010-T2-BL x2



CUBE-1010-T3-BL x2



CUBE-1010-T4-BL x2



CUBE-1010-T5-BL x2

Graphics



CUBE-1010-BL-G x1

Exploded View

CUBE-1010-BL

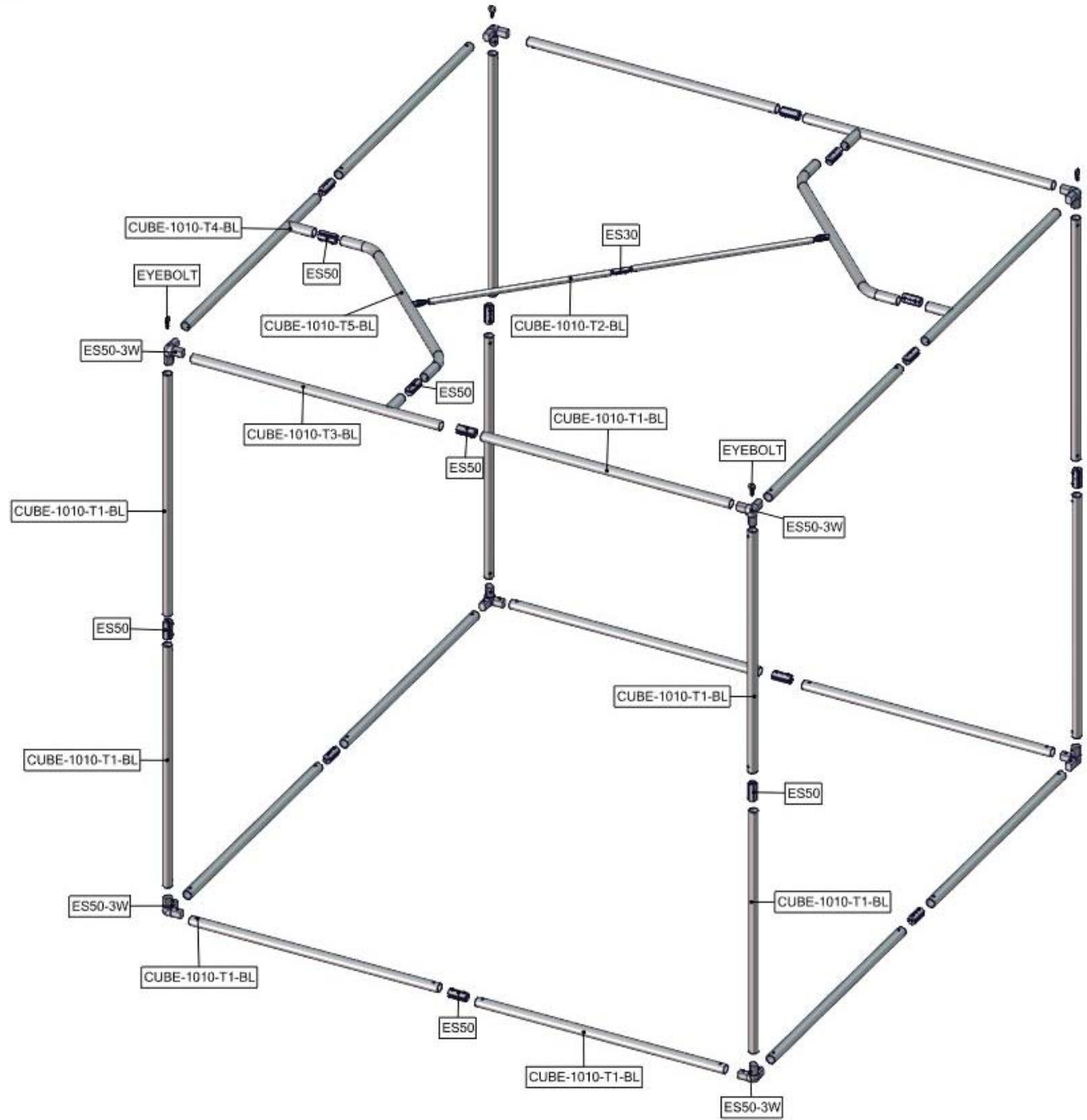

Labeling Diagram

CUBE-1010-BL

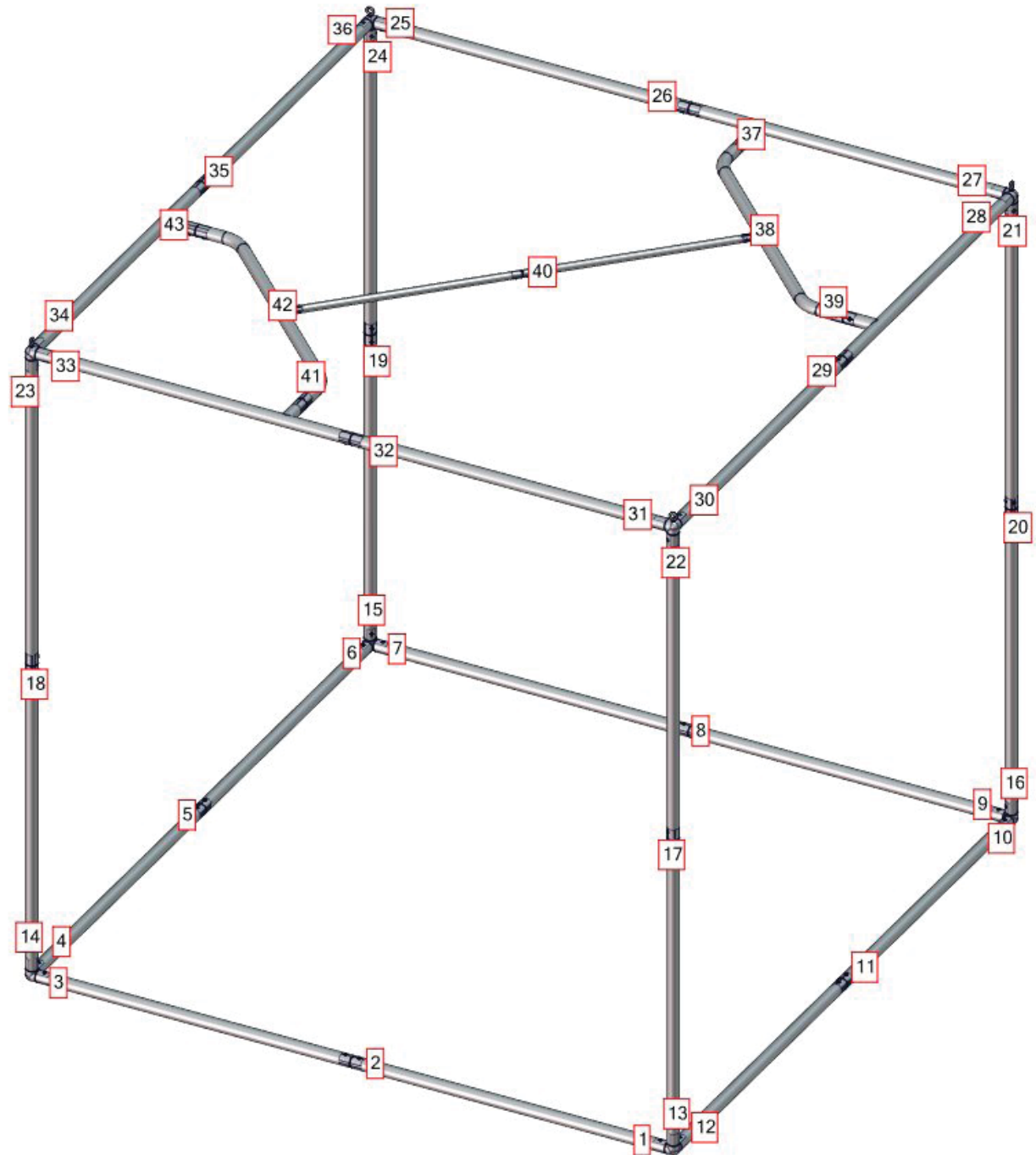

Connection Methods

Formulate® structures use a number of different yet simple connection methods. Your kit will include one or more of the connection methods shown below. Steps within the Kit Assembly will reference a specific method for each connection point.

Connection Method 1: ES30 / ES50 / ES75

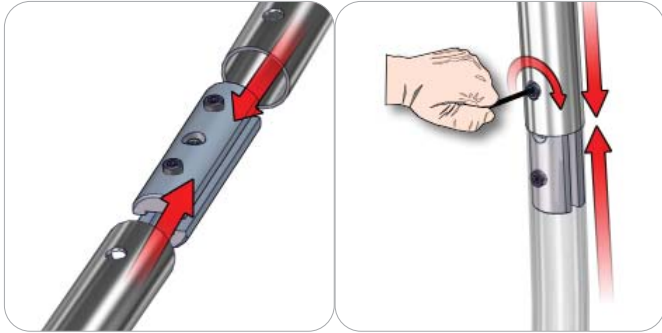

Compress the unlocked connector and slide one tube onto each end. Lock both screws carefully using your allen key tool. Be sure to lock securely, but do not overtighten.

Connection Method 2: Snap Buttons & Swage

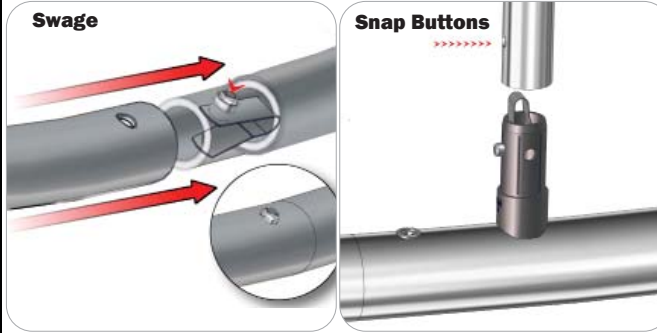

Locate the snap button on the connector or swage tube. Locate the hole on the corresponding tube. Press the snap button with your thumb and slide the tube and connector together so that the snap button snaps fully into the lock hole. To disassemble, press the snap button and pull apart.

Connection Method 3: ES30-90B / ES30-I / ES30-C

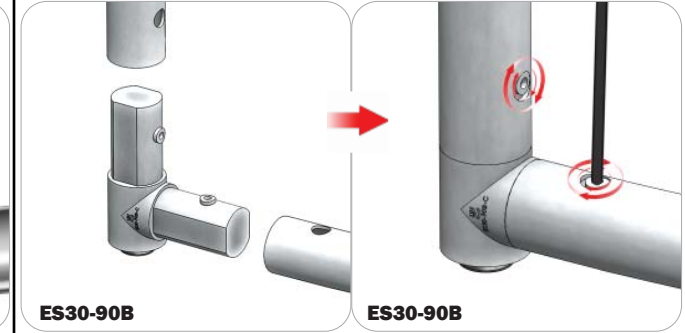

Compress one unlocked end of the connector and slide it through one tube end. Compress the other end of the connector and slide the second tube on. Lock both screws carefully using your allen key tool. Be sure to lock securely, but do not overtighten.

Connection Method 4: Tube Clamps

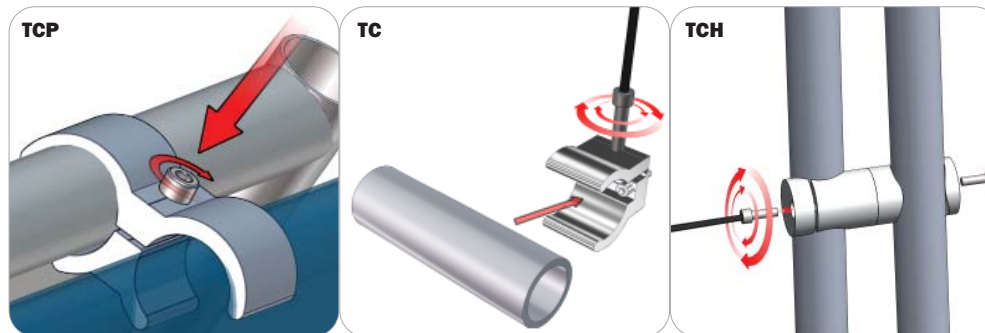

Be sure to fully assemble all frames before using clamps. With the clamp unlocked, place one tube of the first frame into the mouth of the clamp. Place the second tube (if applicable) into the second mouth of the clamp. With both frame's tubes in the clamp, be sure to lock securely, but do not overtighten.

Kit Assembly

Step by Step:

Step 1.

Locate the components necessary for assembling the frame. Reference the exploded view for component layout.

Please reference Connection Methods 1 and 2 for more details.

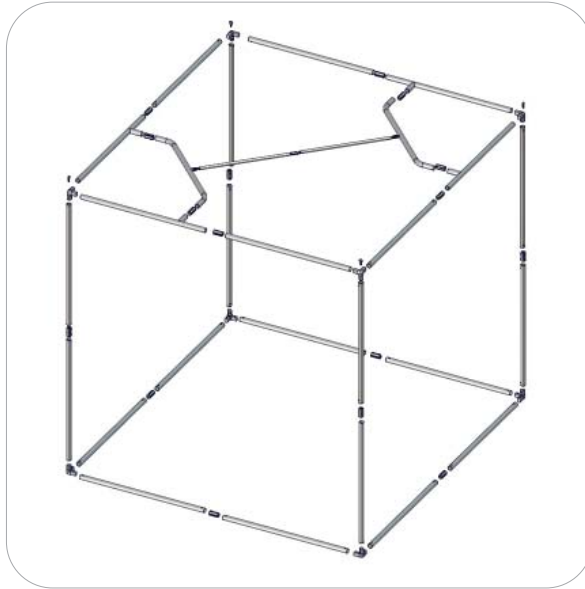

Step 2.

Apply the graphic pillowcase around the frame from the bottom and then zipper around the top edge.

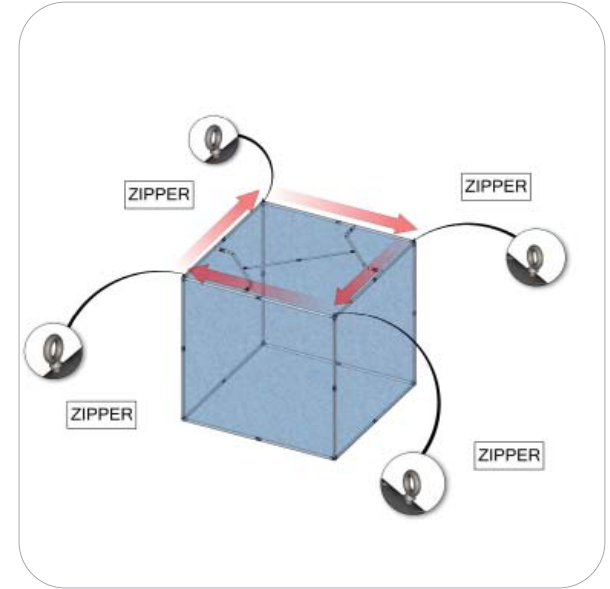
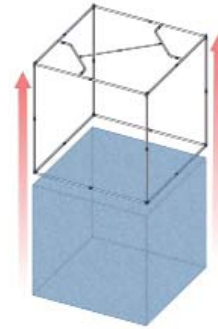

Step 3.

Attach your light cord onto your structure using the WC-30T clamps.

Your structure is now complete.

