

Coyote popup features

The Coyote popup display system combines strength, reliability, and style in a lightweight and easy to use system. It is fully magnetic, making it simple to assemble and disassemble, and is available in a wide range of sizes and configurations.



We are continually improving and modifying our product range and reserve the right to vary the specifications without prior notice. All dimensions and weights quoted are approximate and we accept no responsibility for variance. E&OE. See Graphic Templates for graphic bleed specifications.

features and benefits:

- Some kits include stylish 120 watt floodlights (LED lighting available)
- Available in a variety of sizes and configurations
- Collapses to a fraction of its size
- Choice of two protective plastic wheeled molded shipping cases
- Eco-fi fabric panels, direct-to-substrate, or U.V. printed graphic panels
- Accomodates a variety of accessories such as back lit tower, internal shelving, bubble panel, and case to counter conversion kits
- Unconditional lifetime warranty on frame against manufacturer defects
- Coyote monitor mount bracket: COY-MM-BRKT
- Monitor mount max weight = approx. 15 lbs.

graphics:

Refer to related graphic template for more information.

Visit: www.exhibitors-handbook.com/graphic-templates.com

additional information:

Regal - smooth exhibit & display fabric:

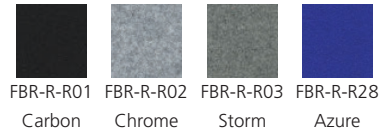

Premier - ribbed exhibit & display fabric:

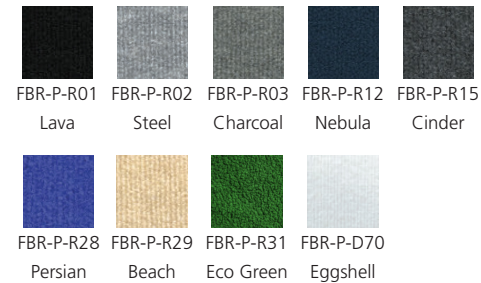

If using a monitor mount on a straight frame, stabilizing feet are needed to prevent the frame from tipping over.

Coyote popup display options



4ft tabletop
(1x1)

- options:
- frame kit
 - frame with fabric endcap kit
 - full fabric kit
 - full graphic kit
 - curved and straight frames available



6ft tabletop
(2x1)

- options:
- frame kit
 - frame with fabric endcap kit
 - full fabric kit
 - full graphic kit
 - curved and straight frames available



8ft tabletop
(3x1)

- options:
- frame kit
 - frame with fabric endcap kit
 - full fabric kit
 - full graphic kit
 - curved and straight frames available



6ft tabletop
(2x2)

- options:
- frame kit
 - frame with fabric endcap kit
 - full fabric kit
 - full graphic kit
 - curved and straight frames available



8ft tabletop
(3x2)

- options:
- frame kit
 - frame with fabric endcap kit
 - full fabric kit
 - full graphic kit
 - curved and straight frames available

Coyote popup display options



4ft display
(1x3)

- options:
- frame kit
 - frame with fabric endcap kit
 - full fabric kit
 - full graphic kit
 - curved and straight frames available

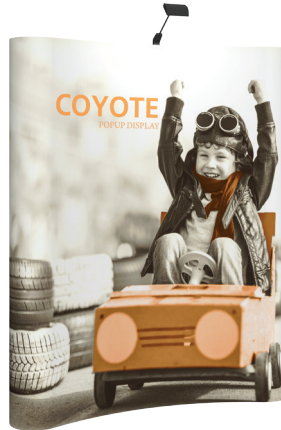

6ft display
(2x3)

- options:
- frame kit
 - frame with fabric endcap kit
 - full fabric kit
 - full graphic kit
 - curved and straight frames available



8ft display
(3x3)

- options:
- frame kit
 - frame with fabric endcap kit
 - full fabric kit
 - full graphic kit
 - available with OCP
 - curved and straight frames available



10ft display
(4x3)

- options:
- frame kit
 - frame with fabric endcap kit
 - full fabric kit
 - full graphic kit
 - available with OCP



Gullwing

- options:
- frame kit
 - frame with fabric endcap kit
 - full fabric kit
 - full graphic kit
 - available with OCP

Coyote popup display options



8ft Serpentine

- options:
- frame kit
 - full fabric kit
 - full graphic kit
 - available with OCP



10ft Serpentine

- options:
- frame kit
 - full fabric kit
 - full graphic kit
 - available with OCP



20ft Serpentine

- options:
- frame kit
 - full fabric kit
 - full graphic kit
 - available with OCP



Horseshoe

- options:
- frame kit
 - full fabric kit
 - full graphic kit
 - available with OCP



Deluxe Horseshoe

- options:
- frame kit
 - full fabric kit
 - full graphic kit
 - available with OCP

Coyote popup accessories



OCX



OCX
Graphic Case to Counter



OCX
Stretch Wrap Case to Counter



Bubble Panel



OCP2
Fabric Counter Conversion Kit



OCP2
Graphic Case to Counter



OCP2
Stretch Wrap Case to Counter



Monitor Mount



OCP Elite
Fabric Counter Conversion Kit



OCP Elite
Graphic Case to Counter



OCP Elite
Stretch Wrap Case to Counter







Internal Shelf Kit







Coyote Tower

Coyote straight and curved tabletop popup display specs





	 Straight 4ft (1x1)	 Straight 6ft (2x1)	 Straight 8ft (3x1)	 Straight 6ft (2x2)	 Straight 8ft (3x2)
Footprint	41.8" w x 30.625" h x 13" d	70.7" w x 30.625" h x 13" d	99.58" w x 30.625" h x 13" d	70.7" w x 59.375" h x 13" d	99.58" w x 59.375" h x 13" d
Approx. Shipping	OCS: 19" l x 45" h x 19" d / 29 lbs	OCS: 19" l x 45" h x 19" d / 33 lbs	OCS: 19" l x 45" h x 19" d / 35 lbs	OCP ELITE: 39" l x 27" h x 18" d / 44 lbs OCX: 40" l x 27" h x 18" d / 44 lbs OCS: 19" l x 45" h x 19" d / 25 lbs	OCP ELITE: 39" l x 27" h x 18" d / 62 lbs OCX: 40" l x 27" h x 18" d / 62 lbs OCS: 19" l x 45" h x 19" d / 26 lbs

*Refer to related graphic template for more information





	 Curved 4ft (1x1)	 Curved 6ft (2x1)	 Curved 8ft (3x1)	 Curved 6ft (2x2)	 Curved 8ft (3x2)
Footprint	45.5" w x 30.625" h x 12.95" d	69.267" w x 30.625" h x 18.472" d	94.5" w x 30.625" h x 24" d	69.27" w x 59.375" h x 18.47"	94.5" w x 59.375" h x 24" d
Approx. Shipping	OCS: 19" l x 45" h x 19" d / 29 lbs	OCS: 19" l x 45" h x 19" d / 33 lbs	OCS: 19" l x 45" h x 19" d / 35 lbs	OCP ELITE: 39" l x 27" h x 18" d / 44 lbs OCX: 40" l x 27" h x 18" d / 44 lbs OCS: 19" l x 45" h x 19" d / 24 lbs	OCP ELITE: 39" l x 27" h x 18" d / 62 lbs OCX: 40" l x 27" h x 18" d / 62 lbs OCS: 19" l x 45" h x 19" d / 27 lbs

*Refer to related graphic template for more information

Coyote straight and curved popup display specs

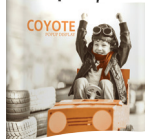

	 Straight 4ft (1x3)	 Straight 6ft (2x3)	 Straight 8ft (3x3)	 Straight 10ft (4x3)
Footprint	41.83"w x 87.56"h x 13"d	70.7"w x 87.56"h x 13"d	99.58"w x 87.56"h x 13"d	128.45"w x 87.56"h x 13"d
Approx. Shipping	OCP ELITE: 39"l x 27"h x 18"d / 56 lbs OCX: 40"l x 27"h x 18"d / 56 lbs	OCP ELITE: 39"l x 27"h x 18"d / 65 lbs OCX: 40"l x 27"h x 18"d / 65 lbs	OCP ELITE: 39"l x 27"h x 18"d / 74 lbs OCX: 40"l x 27"h x 18"d / 74 lbs	OCP ELITE: 39"l x 27"h x 18"d / 74 lbs OCX: 40"l x 27"h x 18"d / 74 lbs

*Refer to related graphic template for more information



	 Curved 4ft (1x3)	 Curved 6ft (2x3)	 Curved 8ft (3x3)	 Curved 10ft (4x3)
Footprint	41.7"w x 87.56"h x 13"d	69.27"w x 87.56"h x 18.5"	94.5"w x 87.56"h x 24"d	116.4"w x 87.56"h x 35"d
Approx. Shipping	OCP ELITE: 39"l x 27"h x 18"d / 56 lbs OCX: 40"l x 27"h x 18"d / 56 lbs	OCP ELITE: 39"l x 27"h x 18"d / 65 lbs OCX: 40"l x 27"h x 18"d / 65 lbs	OCP ELITE: 39"l x 27"h x 18"d / 70 lbs OCX: 40"l x 27"h x 18"d / 70 lbs	OCP ELITE: 39"l x 27"h x 18"d / 81 lbs OCX: 40"l x 27"h x 18"d / 81 lbs

*Refer to related graphic template for more information

Coyote popup display specs

	 8' Serpentine	 10' Serpentine	 20' Serpentine
Footprint	97.62" w x 87.56" h x 20" d	125.25" w x 87.56" h x 21.63" d	219.5" w x 87.56" h x 54.38" d
Approx. Shipping	OCP ELITE: 39" l x 27" h x 18" d / 88 lbs OCX: 40" l x 27" h x 18" d / 78 lbs	OCP ELITE: 39" l x 27" h x 18" d / 93 lbs OCX: 40" l x 27" h x 18" d / 83 lbs	(2) OCP ELITE: 39" l x 27" h x 18" d / 211 lbs (2) OCX: 40" l x 27" h x 18" d / 191 lbs

*Refer to related graphic template for more information

	 Horseshoe	 Deluxe Horseshoe	 Gullwing
Footprint	125" w x 87.56" h x 54.34" d	196.837" w x 87.56" h x 61.28" d	229.4" w x 87.56" h x 35" d
Approx. Shipping	(2) OCP ELITE: 39" l x 27" h x 18" d / 171 lbs (2) OCX: 40" l x 27" h x 18" d / 151 lbs	(2) OCP ELITE: 39" l x 27" h x 18" d / 211 lbs (2) OCX: 40" l x 27" h x 18" d / 212 lbs	(2) OCP ELITE: 39" l x 27" h x 18" d / 211 lbs (2) OCX: 40" l x 27" h x 18" d / 191 lbs

*Refer to related graphic template for more information

Coyote frame footprints

1x1, 1x3 STRAIGHT

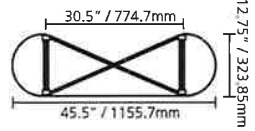

4x3 CURVED

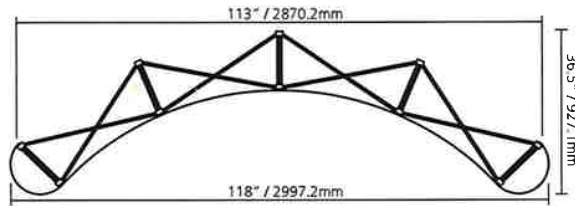

HORSESHOE STANDARD

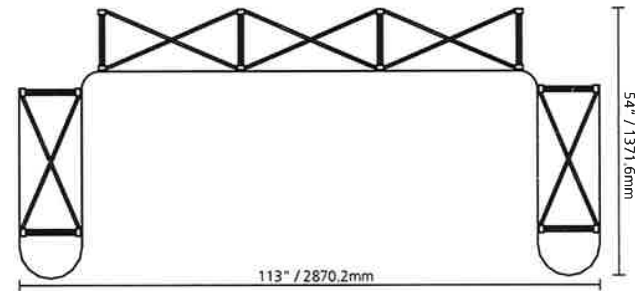

2x1, 2x2, 2x3 STRAIGHT

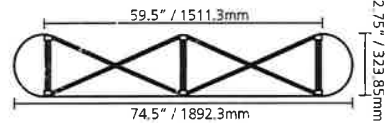

3x1, 3x2, 3x3 CURVED

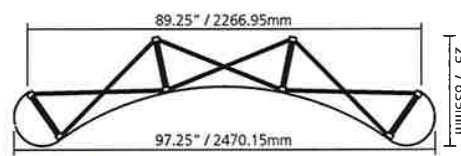

HORSESHOE DELUXE

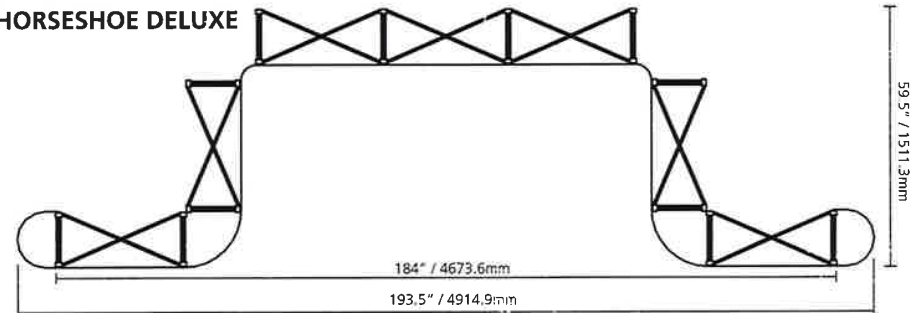

3x1, 3x2, 3x3 STRAIGHT

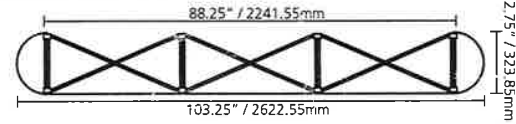

2x1, 2x2, 2x3 CURVED

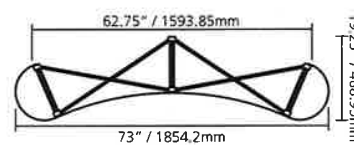

4x3 STRAIGHT

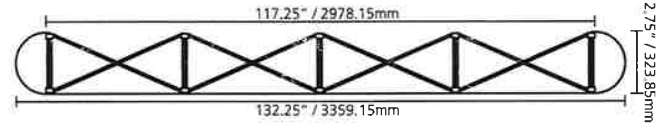

1x1, 1x3 CURVED

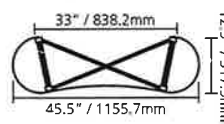

20' SERPENTINE

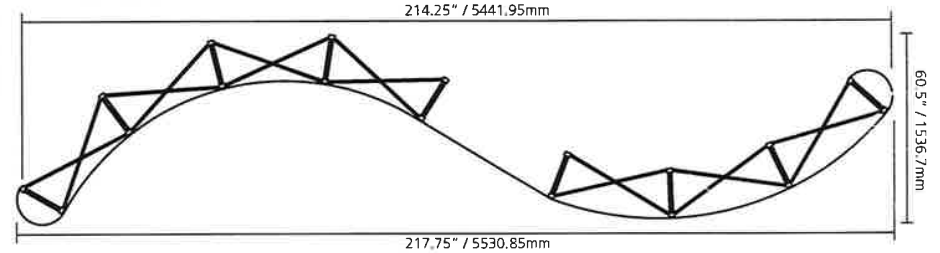

8' SERPENTINE

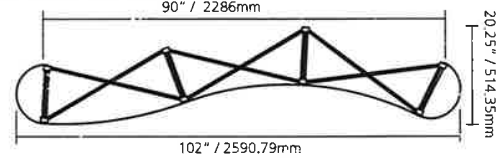

10' SERPENTINE

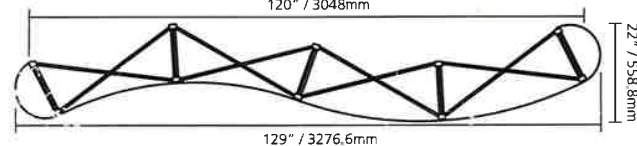

GULLWING

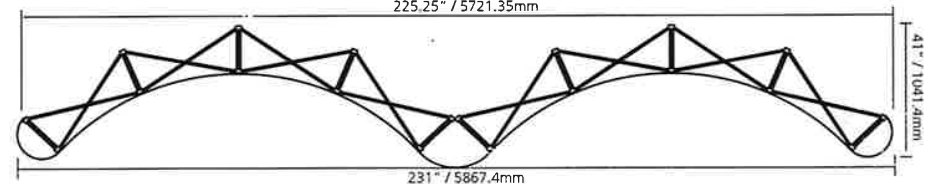

Coyote popup display set up instructions

Frame Assembly

1



Prepare frame for assembly by locating the purple hooks on top of the frame.

2

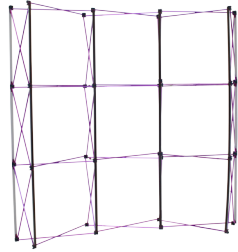

Stretch frame to size, snapping magnetic locking arms together.

3



Attach magnetic channel bars to circular magnets. *To prevent loss of polarity, do not slide the small circular magnet along the flexible strip magnet.

4

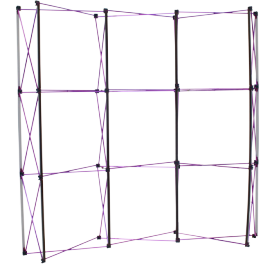

Frame is assembled.

Graphic Application

1



Attach panels starting with left curved endcap panel. Hook panel on purple hooks on front and back of frame. Attach rest of panel to magnetic channel bar.

2



Attach graphic panels from left to right. Hook panels on purple hooks and apply panel to the magnetic channel bar.

3



Continue to attach remaining panels by hooking to purple hooks. Make sure all panel edges align with middle line on channel bars.

4



Graphic application is complete.

Stabilizer Feet Application

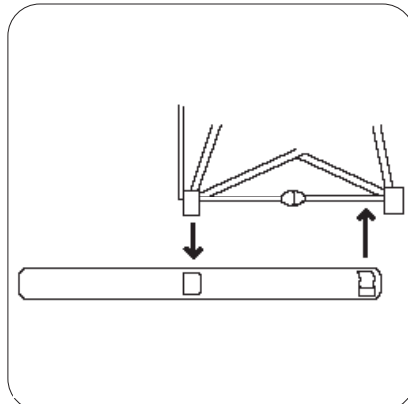
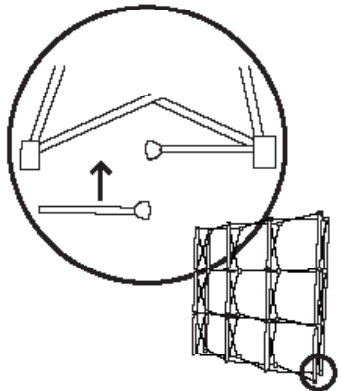

Coyote popup accessory instructions - Bubble Panel

Assembly

1

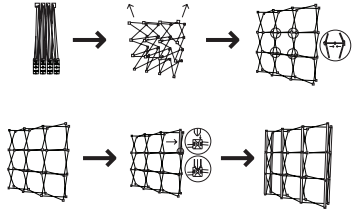

Assemble Coyote frame as directed on page 9.

2

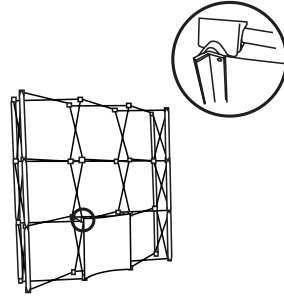

Attach channel bars with L bracket on middle of frame. Hook bottom panel to frame and channel bar.

3

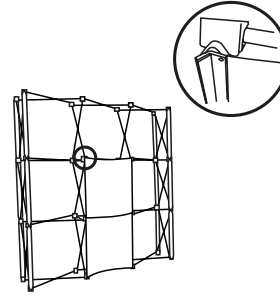

Hook middle panel to frame and channel bar.

4

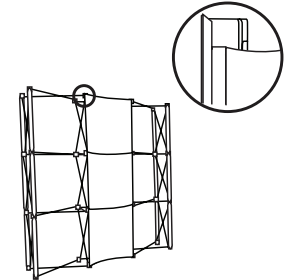

Hook top panel to frame and channel bar.

5

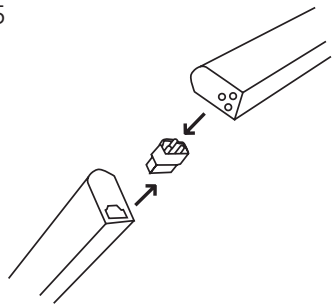

Connect electrical prong to light strips.

6

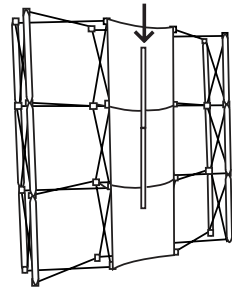

Attach lights to velcro strip on panels.

7

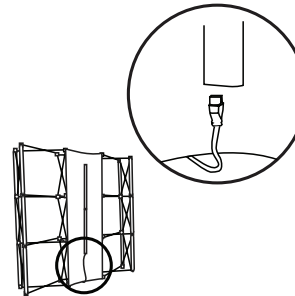

Snake power cord from under frame and connect to light source.

Graphic Assembly

8

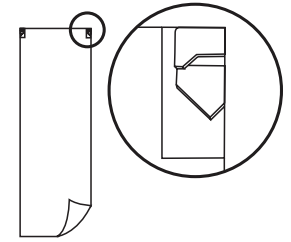

Locate purple hook on the top of the bubble panel.

9

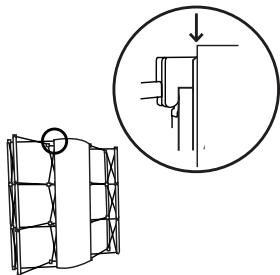

Hook left side of purple hook into L bracket. Bend panel and repeat for the right side.

10



Display is complete.

Coyote popup accessory instructions - Monitor Mount

COYOTE MONITOR MOUNT BRACKET: COY-MM-BRKT

Assembly

1

Assemble Coyote frame as directed on page 9.

2

Apply all graphic panels, excluding the center.

3

Attach vertical bar onto frame.

4

Lock the horizontal bar onto the vertical bar by tightening the screw into place.

5

Apply center graphic panel and make sure opening is at the top of the display.

6

Locate the monitor and attach the bracket on the back.

7

Attach the monitor bracket to the horizontal pole. Tighten in place.

8

***Monitor mount max weight = approx 15 lbs.**

Display is complete.

monitor with attached monitor bracket

VESA Monitor Patterns: 50, 75 and 100

50mm pattern

75mm pattern

100mm pattern

horizontal bar
(3 sizes, large for rear curve panel, medium for straight panel, small for front curved panel)

vertical bar

monitor bracket

monitor (not provided)

Coyote popup accessory instructions - Internal Shelf

Assembly

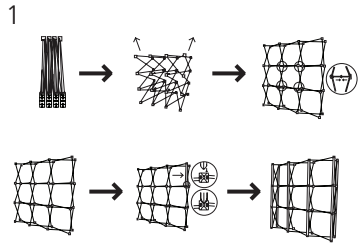

Assemble Coyote frame as directed on page 9.

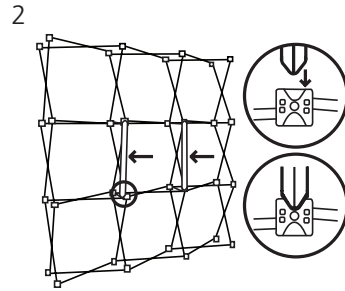

Apply magnetic channel bars to frame.

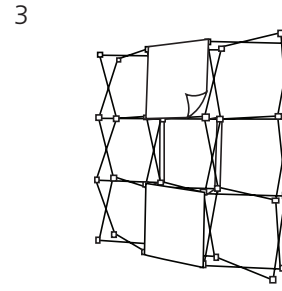

Attach top and bottom graphic panels to frame.

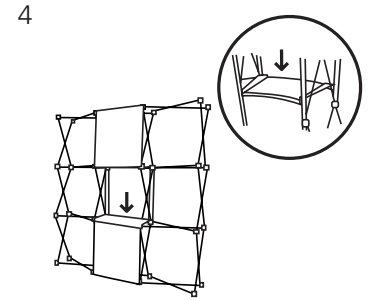

Place black plastic panel in middle of frame on the bottom.

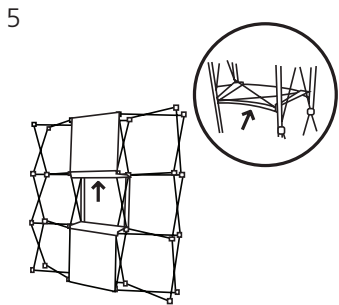

Insert a black plastic panel into the top of middle frame and hold in place.

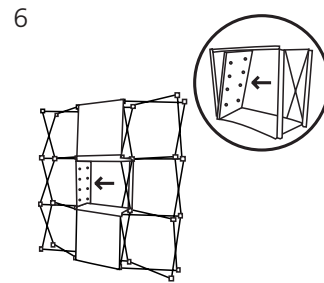

While holding top siding in place, insert left vertical siding.
*Make sure the sides have grooves for shelf.

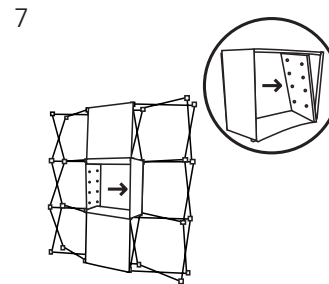

Continue holding the top shelf and insert right side. *Make sure the sides have grooves for shelf.

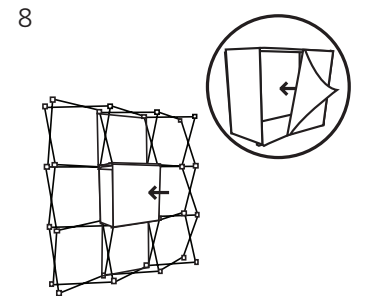

Place graphic panel on the back of the frame, behind middle opening to enclose the space.

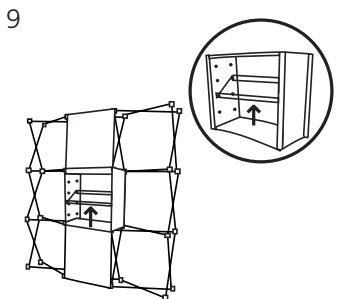

Insert clear shelving using the grooves on black plastic panels to hold in place.

Graphic Application

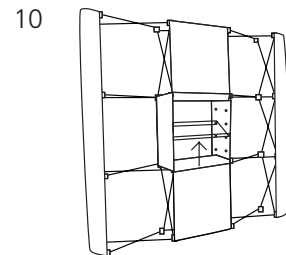

Start attaching graphic panels, doing the end caps first then center graphics.



Display is complete.

Optional Light Kit

12 **Includes:**
2 puck lights, power cord & power adapter

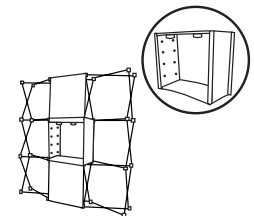

Lights will come pre-installed in top of shelf kit.

Coyote accessory instructions - Tower

Assembly

1

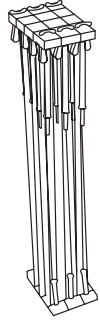

Prepare frame for assembly.

2

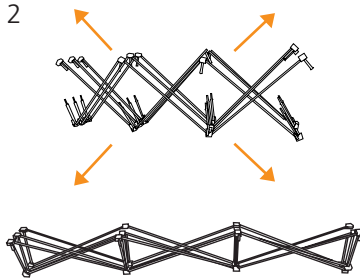

Pull frame apart and lock green connectors.
*If lights are included continue with step 3, if lights aren't included, skip to step 5.

3

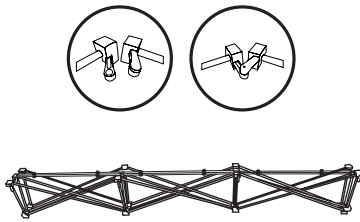

Apply channel bars with metal light clips to center of frame.
*Make sure grey latches are on top. This indicates the center of frame when frame is standing.

4

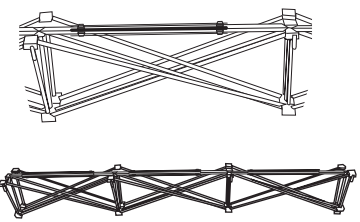

If lights are included, attach lights to clips on channel bars. Then connect the cords to the lights.

Graphic Assembly

5

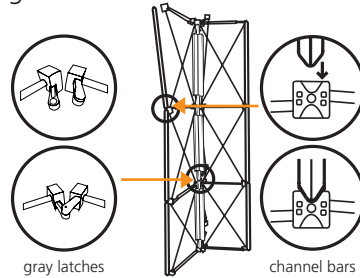

Stand and twist frames outward. Connect gray latches located in middle of frame. Apply channel bars to frame.

1

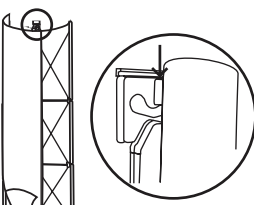

Apply graphic by hooking top of panel to the purple hook. Repeat for remaining graphic panels.

2



3



4



Display is complete

Coyote popup OCX packing instructions

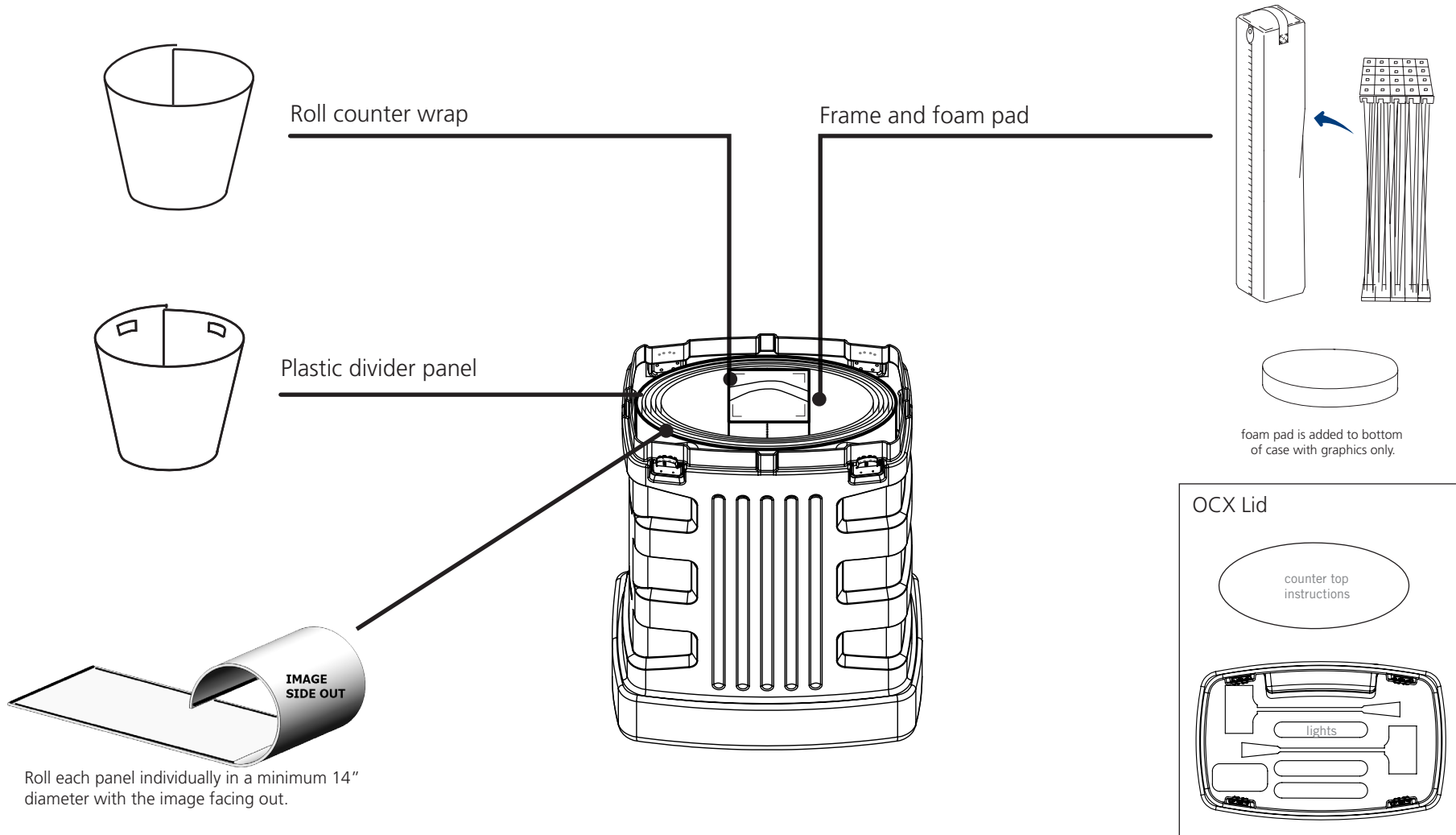

Packing instructions

1. Roll counter wrap with plastic facing out and place inside the case against the outside wall.
2. Individually roll panels and place inside case until all panels are in the case and against the outside wall. (fabric to fabric/ magnet to magnet)
3. Pack channel bar into the storage bag. Then release magnetic locking arms to collapse the frame.
4. Place foam pad in bottom of case then pack frame and bag in the center.
5. Counter top snaps inside lid holding the lights in place.
*Allow lights to cool before packing.

Coyote popup OCP Elite packing instructions

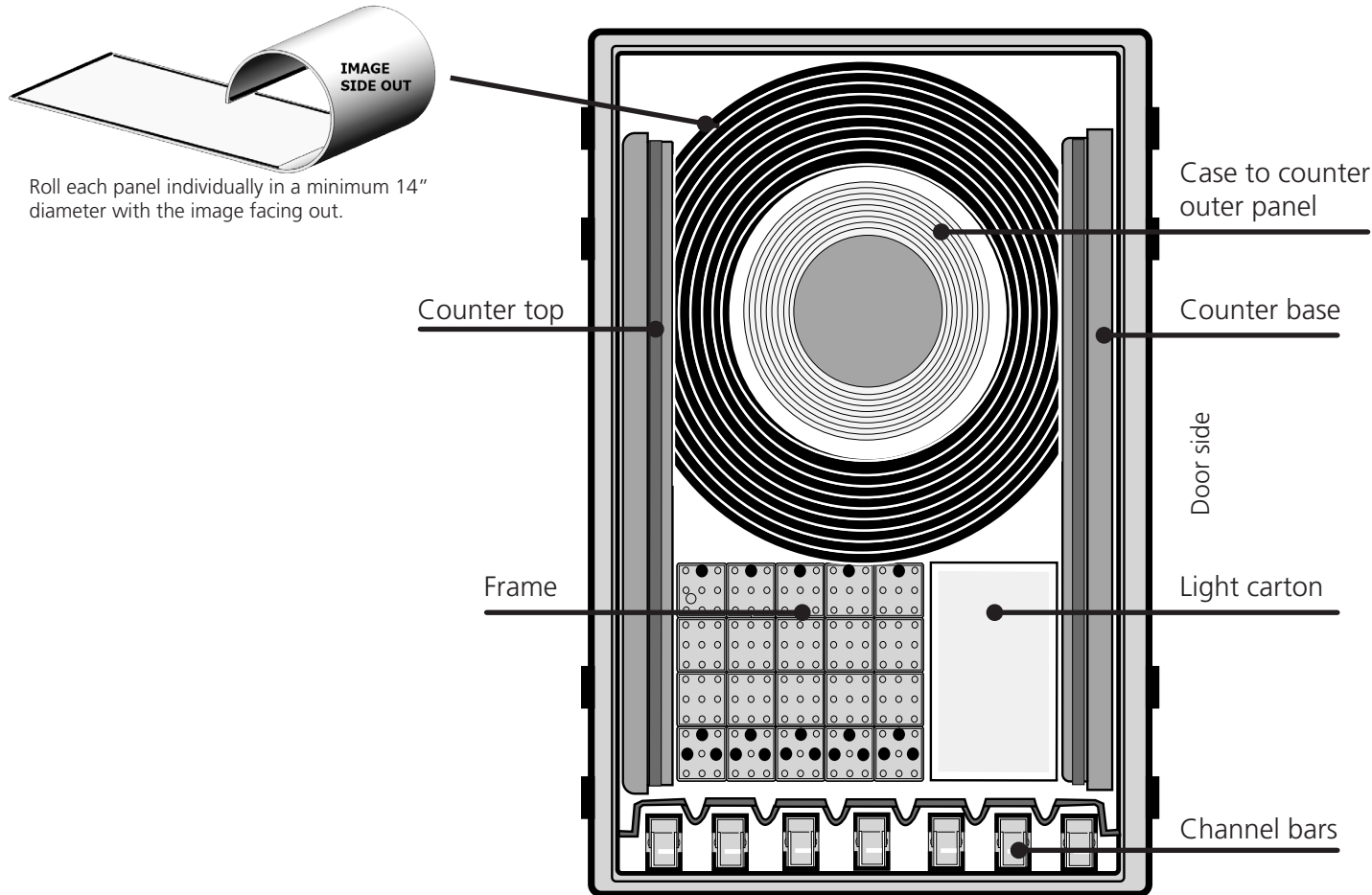

Packing instructions

1. Insert channel bars upright into the holder in the bottom of the case. Slide the counter base into the case along the door side.
2. Place the counter top in the protective bag, then place it in the case along the side opposite the door.
3. Pack the frame next to the channel bar holder.
4. Place the wrapped panels between the counter base and counter top.
5. Roll up the case-to-counter outer panel. Secure it with rubber bands and insert it in the center of the wrapped panels into the well in the bottom of the case.
6. Slide the light carton between the frame and counter base.