

JOLLY EXHIBIT

10 W x 7.5 H PRODUCT CODE: JOLLYE

SET UP INSTRUCTIONS

1. SET UP POP UP FRAME



A. Place frame with the adjustable feet facing down.

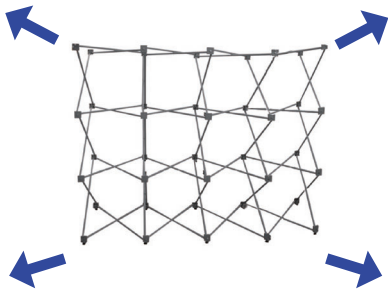

B. Expand the frame

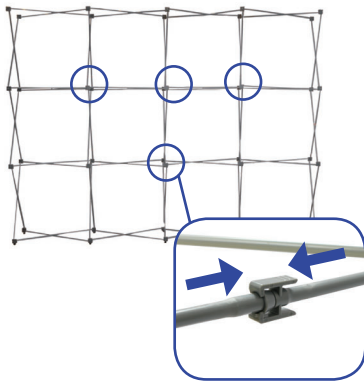

C. Close frame by pushing the outside of the frame until male and female ends connect.

2. INSERT CHANNEL BARS

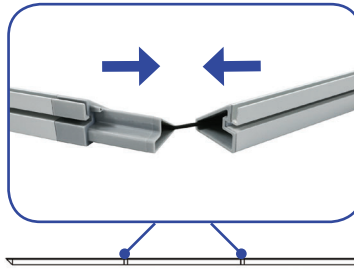

A. Expand each channel bar. Follow bungee to connect.

B. Attach channel bars to frame.

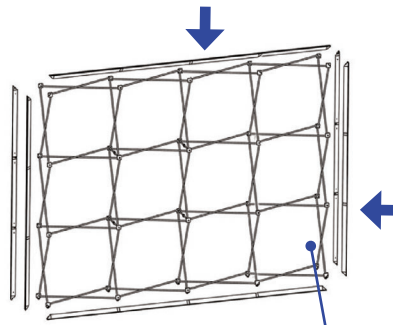

C. Slide channels bars onto frame, from top to bottom, then secure onto metal peg.

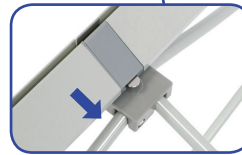

D. Attach the top and bottom endcaps on each side of the frame.



3. INSTALL GRAPHIC

A. In each corner, insert the silicone edge beading into the groove.



B. Then insert the remainder of the beading.



C. Repeat graphic installation on the end caps.

OPTIONAL ACCESSORIES



Scan For JOLLY Video Set Up

Stabilized Feet:

A. From the back, lift frame and insert adjustable feet onto stabilized feet. Then slide stabilized feet toward and insert onto the adjustable feet.

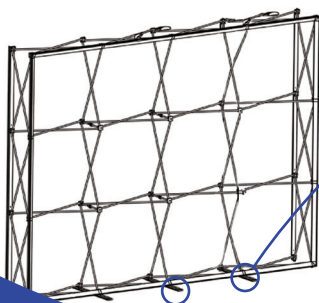

Light Bracket:

A. Snap the LED Light Bracket on top of the frame. Then slide the LED Light onto the bracket.

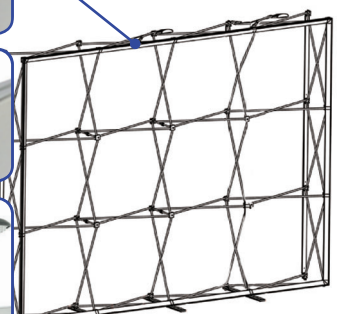

JOLLY EXHIBIT

2.5 W x 7.5 H PRODUCT CODE: JOLLYE

SET UP INSTRUCTIONS

1. SET UP POP UP FRAME



A. Place frame with the adjustable feet facing down.

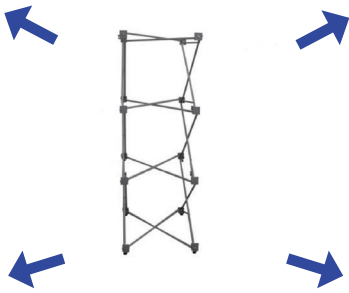

B. Expand the frame

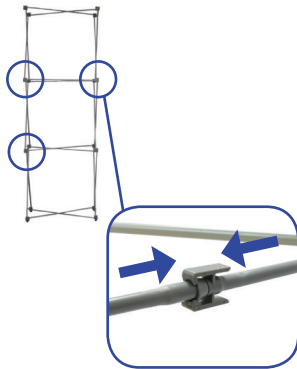

C. Close frame by pushing the outside of the frame until male and female ends connect.

2. INSERT CHANNEL BARS

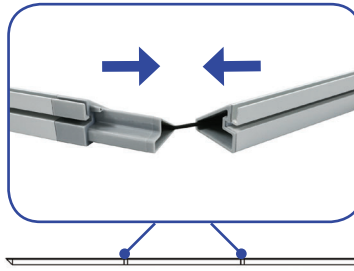

A. Expand each channel bar. Follow bungee to connect.

B. Attach channel bars to frame.

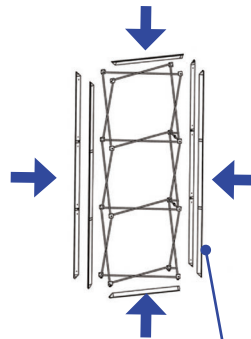

C. Slide channels bars onto frame, from top to bottom, then secure onto metal peg.



D. Attach the top and bottom endcaps on each side of the frame.

3. INSTALL GRAPHIC

A. In each corner, insert the silicone edge beading into the groove.



B. Then insert the remainder of the beading.



C. Repeat graphic installation on the end caps.

OPTIONAL ACCESSORIES



Scan For JOLLY Video Set Up

Stabilized Feet:

A. From the back, lift frame and insert adjustable feet onto stabilized feet. Then slide stabilized feet toward and insert onto the adjustable feet.

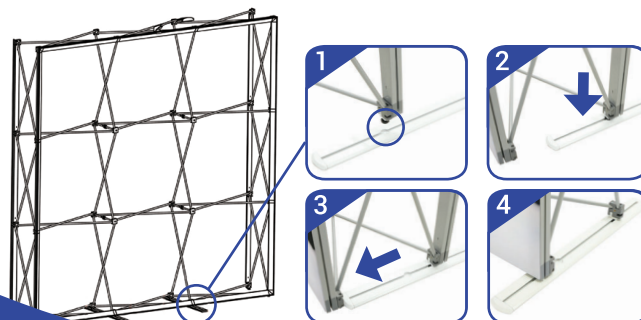

Light Bracket:

A. Snap the LED Light Bracket on top of the frame. Then slide the LED Light onto the bracket.

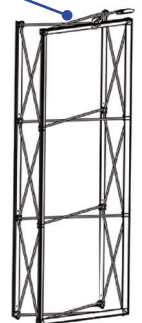
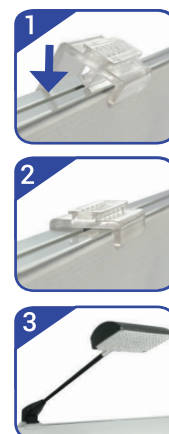

PRODUCT CODE: JOLLYE

1. SET UP POP UP FRAME



A. Place frame with the adjustable feet facing down.



B. Expand the frame



C. Slightly expand the frame again to set up the Channel Bar connection.

2. INSERT CHANNEL BARS

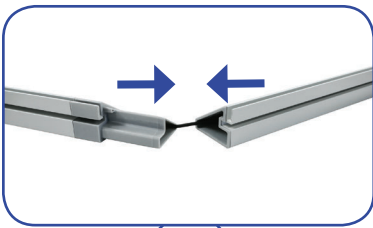

A. Expand each Channel Bars. Follow bungee to connect.

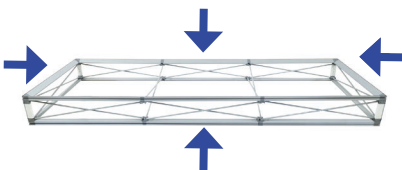

B. Attach channel bars to frame.

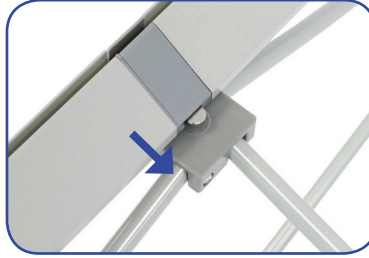

C. Slide Channels Bars onto the frame, from top to bottom, then secure onto metal peg.



D. Attach the End Cap Channel Bars on each side of the frame.

3. INSTALL GRAPHICS

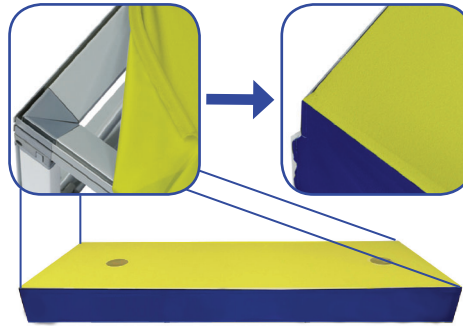

A. In each corner, insert the silicone edge beading into the groove.

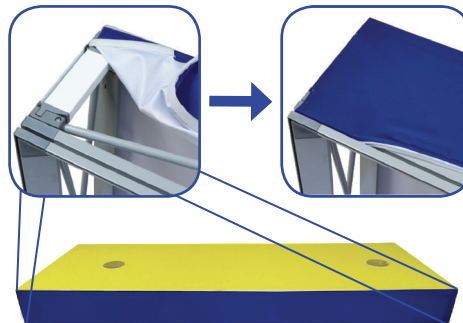

B. Install the end cap graphics on each side of the frame. Then insert the remainder of the beading.

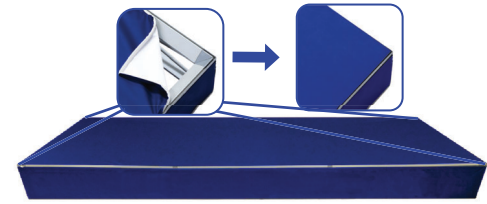

D. Flip the frame over. In each corner, insert the silicone edge beading into the groove.

4. CONNECT BRIDGE CONNECTORS TO FRAME



A. Use Bridge Connectors for Bridge frame.

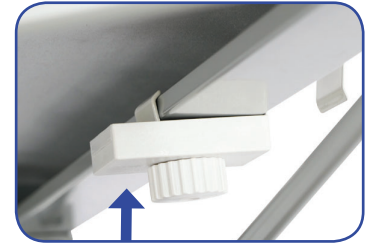

B. Place the connector onto the upper section of the Channel Bar.



C. Turn the dial to the right to lock the connector.

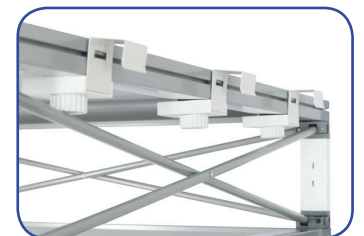

D. Repeat for the other connectors and other end of frame. Make sure each connectors are spread apart.

L LINK CONNECTION (RETURN WALL)

Adjoin the 3x3 and 4x3 frames at a 90° angle. Starting from behind, pull the 4x3 graphic away to make space for the L Connector. Place the L Connector onto the channel bars of both frames. Turn the dial to the left to lock the L Connector into place. Repeat for each vertical section (3 total).

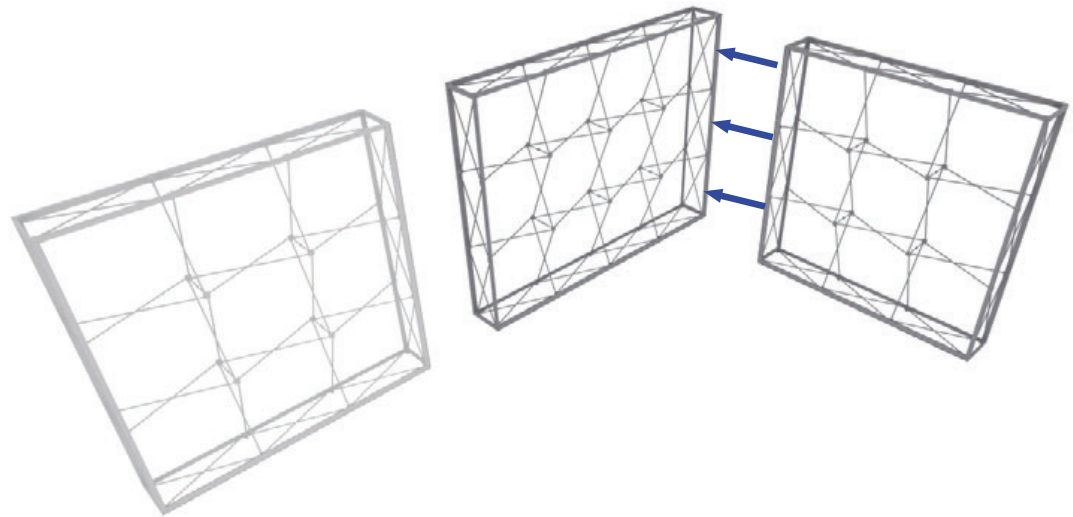
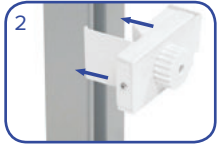

STRAIGHT CONNECTION (SIDE EXTENSION)

Adjoin both 3x3 and 4x3 frames, side by side. Place a straight connector directly in the middle (outside channel bar of each frame) of both frames. Turn the dial to the left to lock in place. Repeat for front and back vertical sections (6 total).

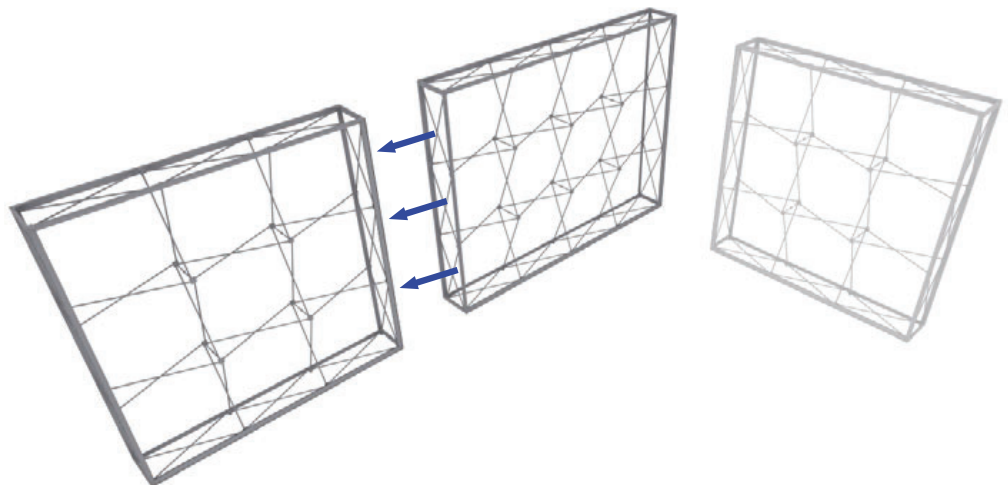

PRODUCT CODE: JOLLYE

1. ASSEMBLE MONITOR MOUNT

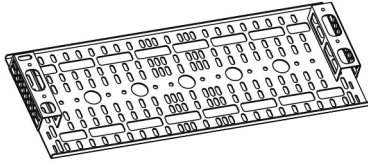

- A.** Place mounting plate face down.

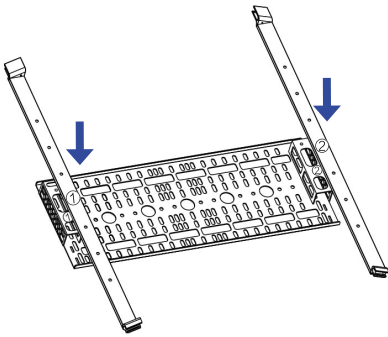

- B.** Place support struts in desired location on mount.
(Match #'s on struts with mounting plate. Struts are also marked top & bottom)

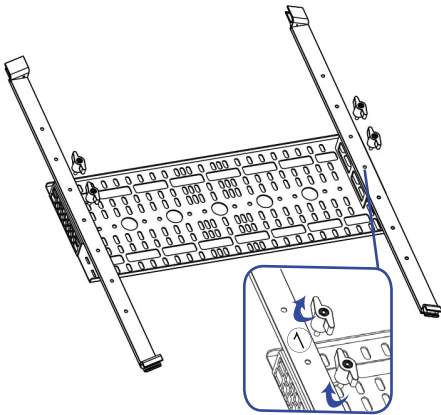

- C.** Attach support struts with the supplied wing nuts.

2. INSTALLATION ON FRAME

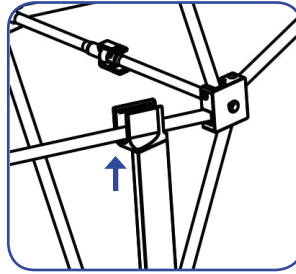

- A.** Slide top brackets onto X bars on frame.

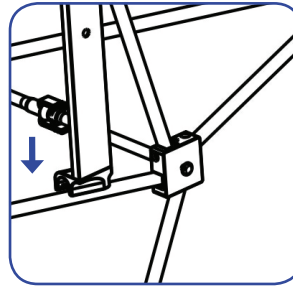

- B.** Rest bottom brackets on bottom X bars on frame.

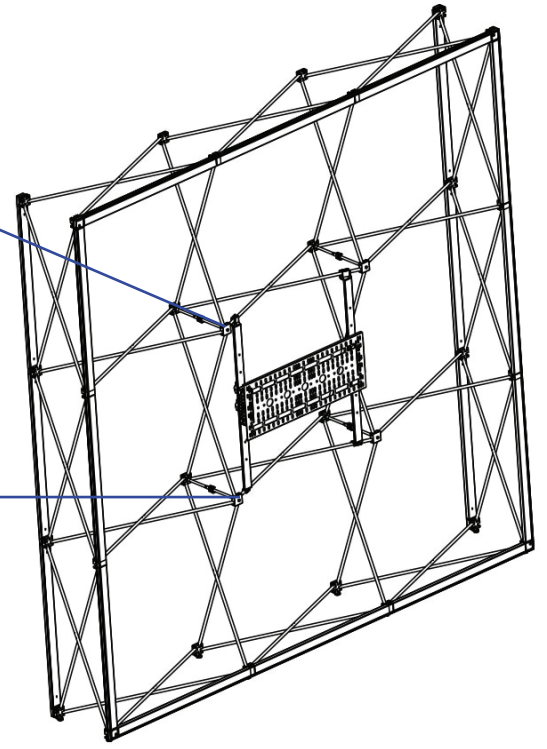

Mount Zoom-ins

*If installing on backlit frame, place monitor mount on backside of the display (opposite side the lights are mounted on)

1. INSTALL SHELF BRACKET



A. Place the Middle Support Bracket on the back side of the Support Brackets.



B. At each end of the Middle Support Bracket, align the holes with the Side Shelf Brackets with holes.

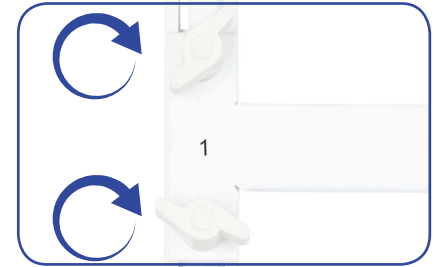

C. Then insert the screw knobs to tighten and secure.

Repeat process for other shelf.

2. INSERT SHELF BRACKET TO FRAME

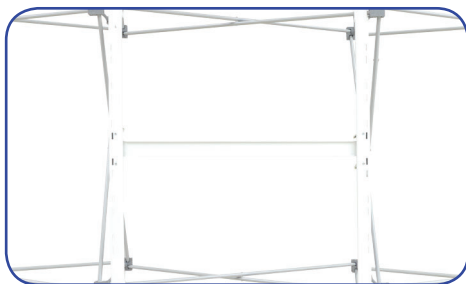

A. Place Shelf Bracket on the middle front of the frame. Make sure to follow label that says "UP" or "DOWN".



B. Place the top bracket on the top "x" bar.



C. Place the bottom bracket on the bottom "x" bar.

3. INSTALL FRONT GRAPHIC AND METAL BRACKETS

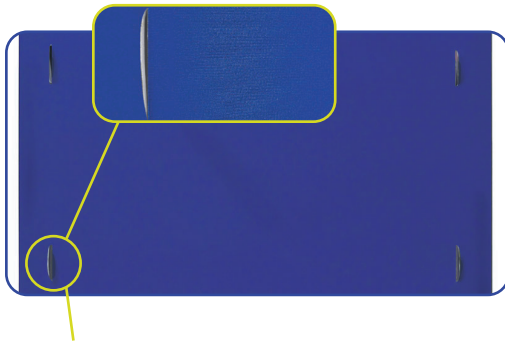

A. Install the front graphic of the frame. Locate four of the pre-cut slots.

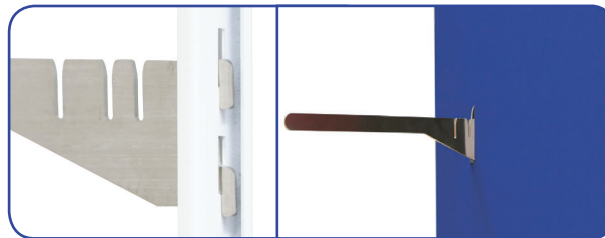

B. Check the back side of the frame and make sure the Metal Brackets are hook onto the slots. Insert the Metal Bracket into the pre-cut slot of the graphic and is hook onto the Side Shelf Bracket slot.

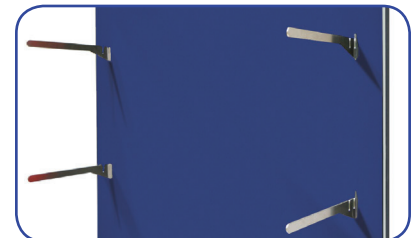

C. Repeat process for other Metal Brackets.

5. PLACE EXTERNAL SHELVES

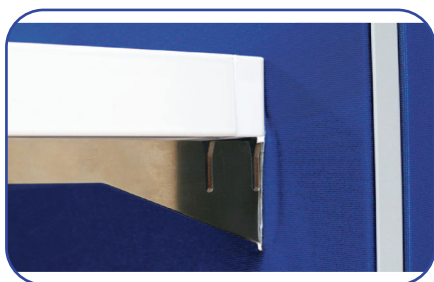

A. Slide the Shelf down onto the Metal Brackets. The Metal Brackets' slots secures the Shelf.



B. The Metal Brackets should be inside the grooves of the bottom Shelf.



C. Repeat process for other shelf.