

MODCO 4 - 20X10

MODCO MODULAR EXHIBITS
PRODUCT CODE: MODCO4-20x10G



On frame



On graphic







FRONT



BACK

PRODUCT DESCRIPTION

Modco Modular Exhibits Modular 4 is a three-dimensional 20' x 10' pre-designed exhibit booth. Stylish and lively, Modco Modular Exhibits Modular 4 is built using tool-free perforated modular aluminum frames. Multiple size frames connect using simple toolless pin connectors. Use shelves to showcase your products. Customize double-sided stretch fabric SEG graphics for the entire exhibit. Perforations are completely covered for a flawless finish.

DISPLAY DIMENSIONS	234.375"W x 97.9"H x 117.5"D		
GRAPHIC SIZES	PANEL	SIZE	QTY
	A	196.375"W x 96.25"H	1
	B	235.375"W x 96.25"H	1
	C	35.25"W x 94.375"H	1
	D	20.5"W x 96.25"H	2
	E	40.125"W x 96.25"H	2
	F	40.125"W x 109.125"	1
	G	40.125"W x 109.125"	1
	H	39.125"W x 97.75"	2
TOTAL PRINTS			11

GRAPHIC MATERIAL

Stretch Fabric w/Integrated Block Out

GRAPHIC FINISHING

Silicone beading is sewn around the perimeter of the fabric graphic. Silicone beading is hidden from view once installed.

DISPLAY CONSTRUCTION

Aluminum frame and components

SHIPPING WEIGHTS & DIMENSIONS (FREIGHT ONLY)

Shipping Weight	1107 lbs (frame & graphics in crate)
Shipping Dimensions	103"L x 44"W x 58"H (in crate)

GRAPHIC TURN AROUND TIME

5 business days after proof approval

AVAILABILITY	CA only
--------------	---------

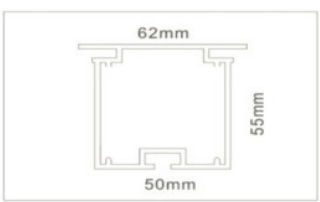
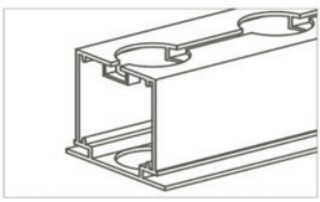

FRAME ONLY

PARTS LIST

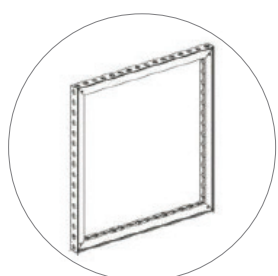

(qty 9)
MOD-FRM-992x2418

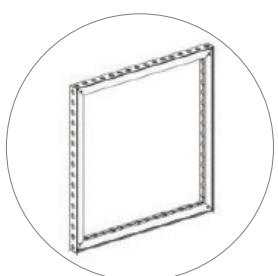

(qty 1)
MOD-FRM-310x1984

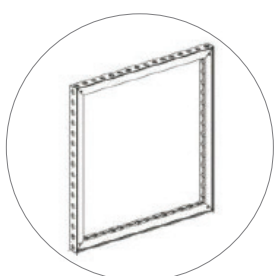

(qty 1)
MOD-FRM-992x1984



(qty 1)
MOD-CRVFRM-774x992

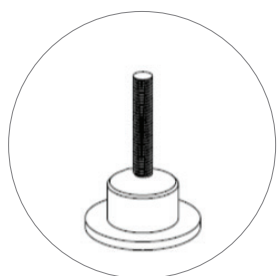

(qty 4)
MOD-PCWP-B



(qty 1)
MOD-DSWL-992x2418



(qty 4)
MOD-SN28mm

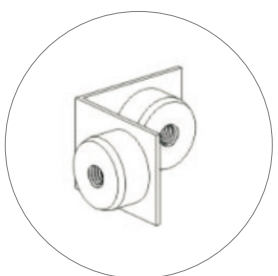

(qty 16)
MOD-90D-CON

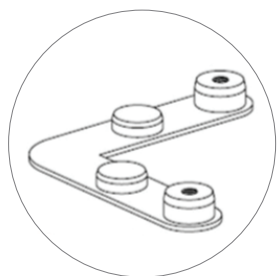

(qty 6)
MOD-SM90D-CON

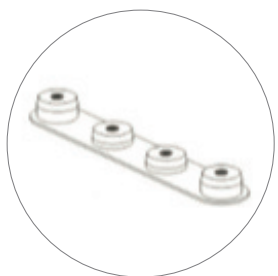

(qty 2)
MOD-CRV-180DCL

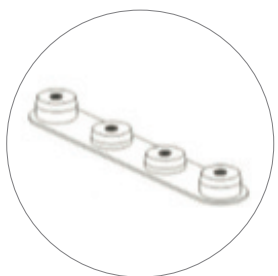

(qty 2)
MOD-CRV-180DCR

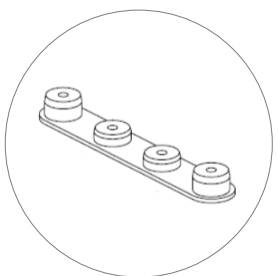

(qty 8)
MOD-180D-CON



(qty)
MOD-CP-3100

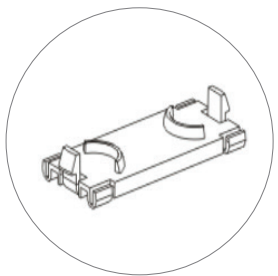

(qty 23)
MOD-CC



(qty 80)
MOD-PC



(qty 2)
MOD-CP-774

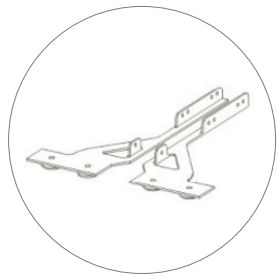

(qty 4)
MOD-SHELF-KIT-INS



(qty 4)
MOD-PC-DOOR

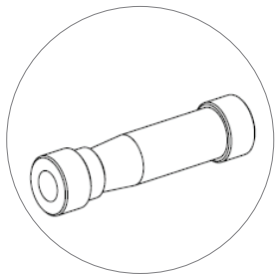

(qty 10)
MOD-CLA-CON

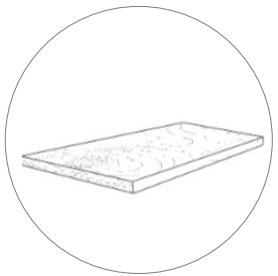

(qty 4)
MOD-PNL

SET UP INSTRUCTIONS

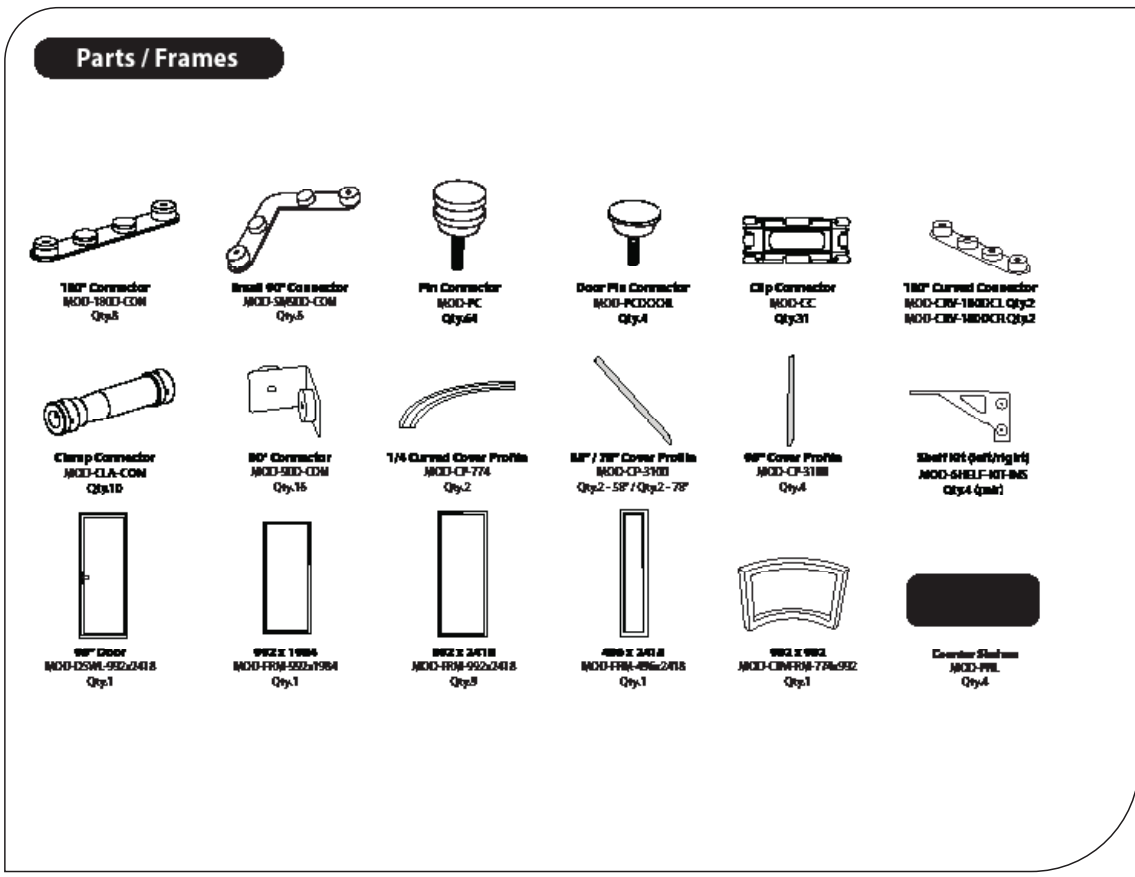
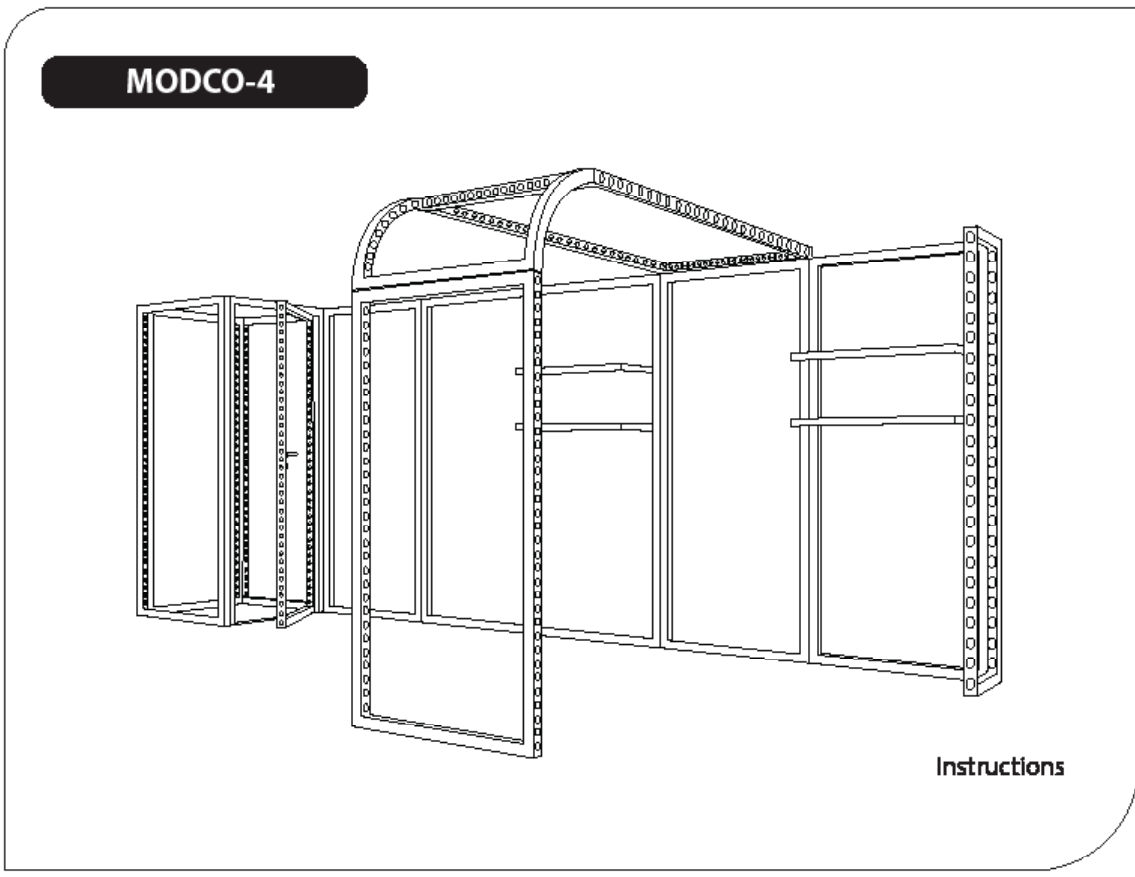

Connections I

A

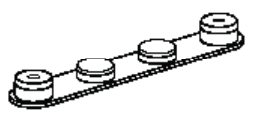

MOD-180D-CON / MOD-PC

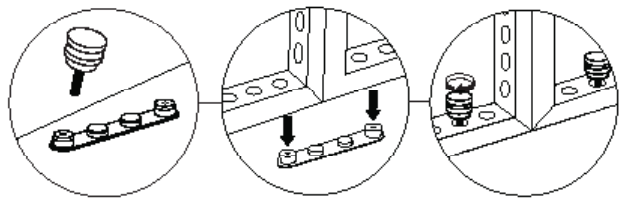

B

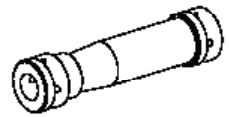

MOD-CLA-CON

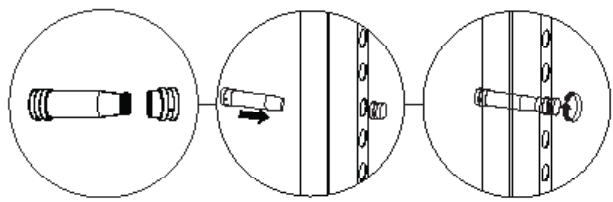

C

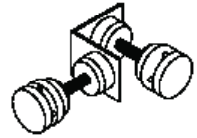

MOD-90D-CON + MOD-PC

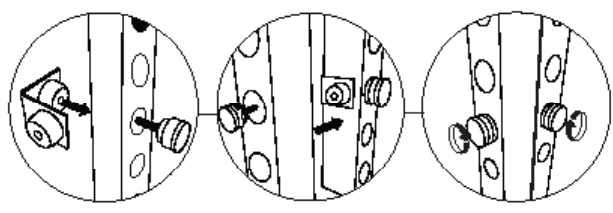

Connections II

D

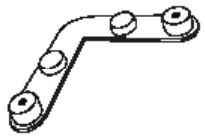

MOD-SM90D-CON / MOD-PC

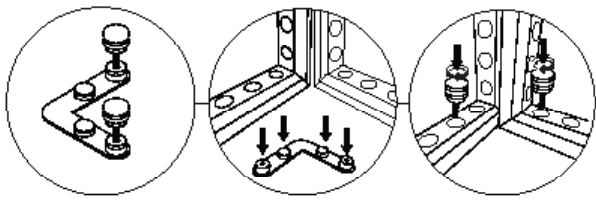

E

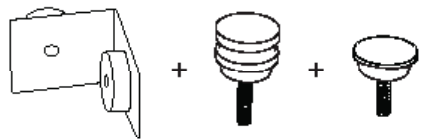

MOD-90D-CON / MOD-PC / MOD-PCDOOR
*Same as (C) but MOD-PCDOOR will be inside of door jam

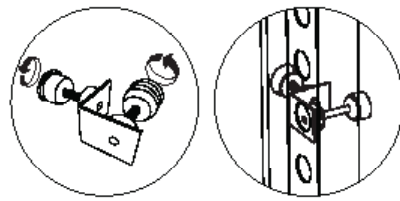

F

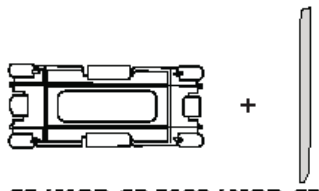

MOD-CC / MOD-CP-3100 / MOD-CP-774

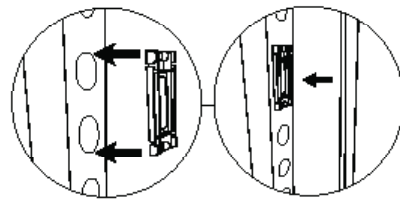

Connections III

G

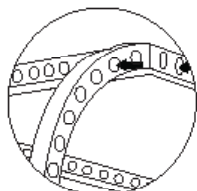
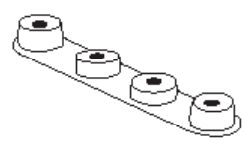

OUTSIDE

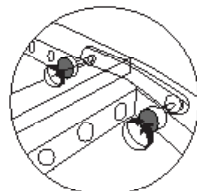

INSIDE

H

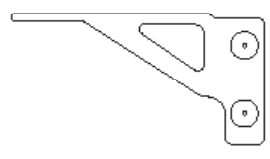

MOD-SHELF-KIT-INS

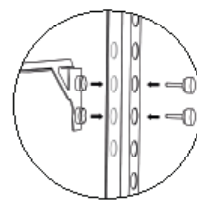

INSIDE OF FRAME

1

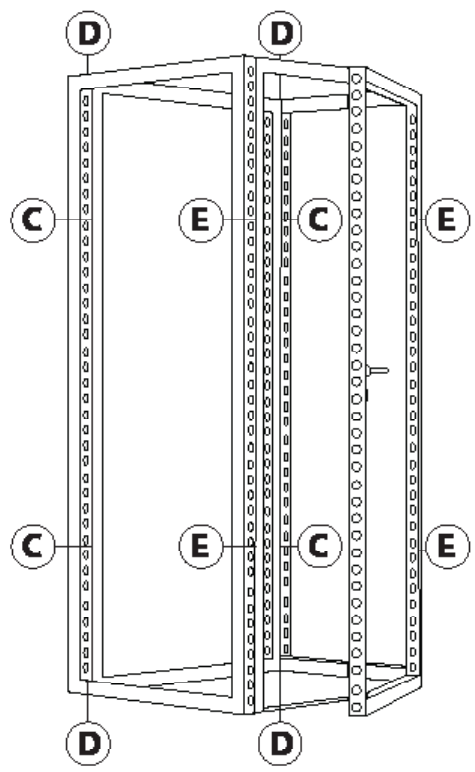

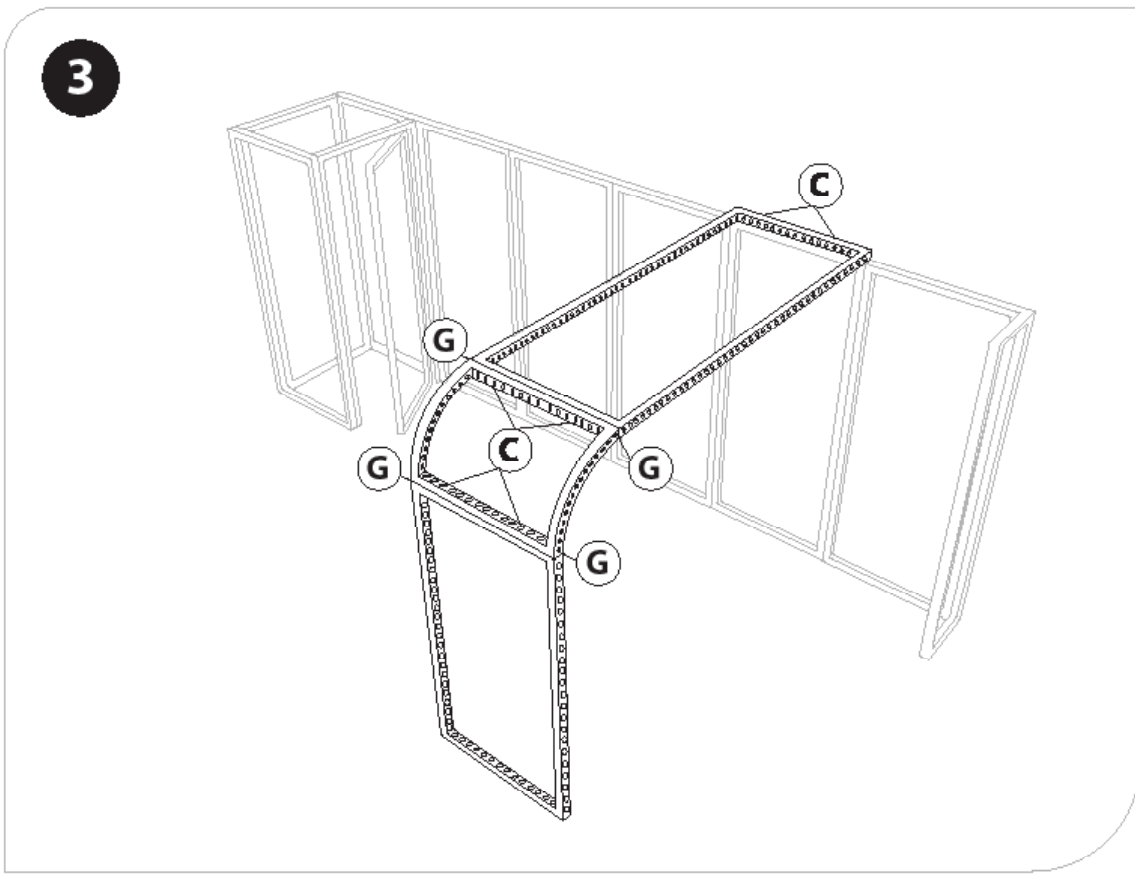
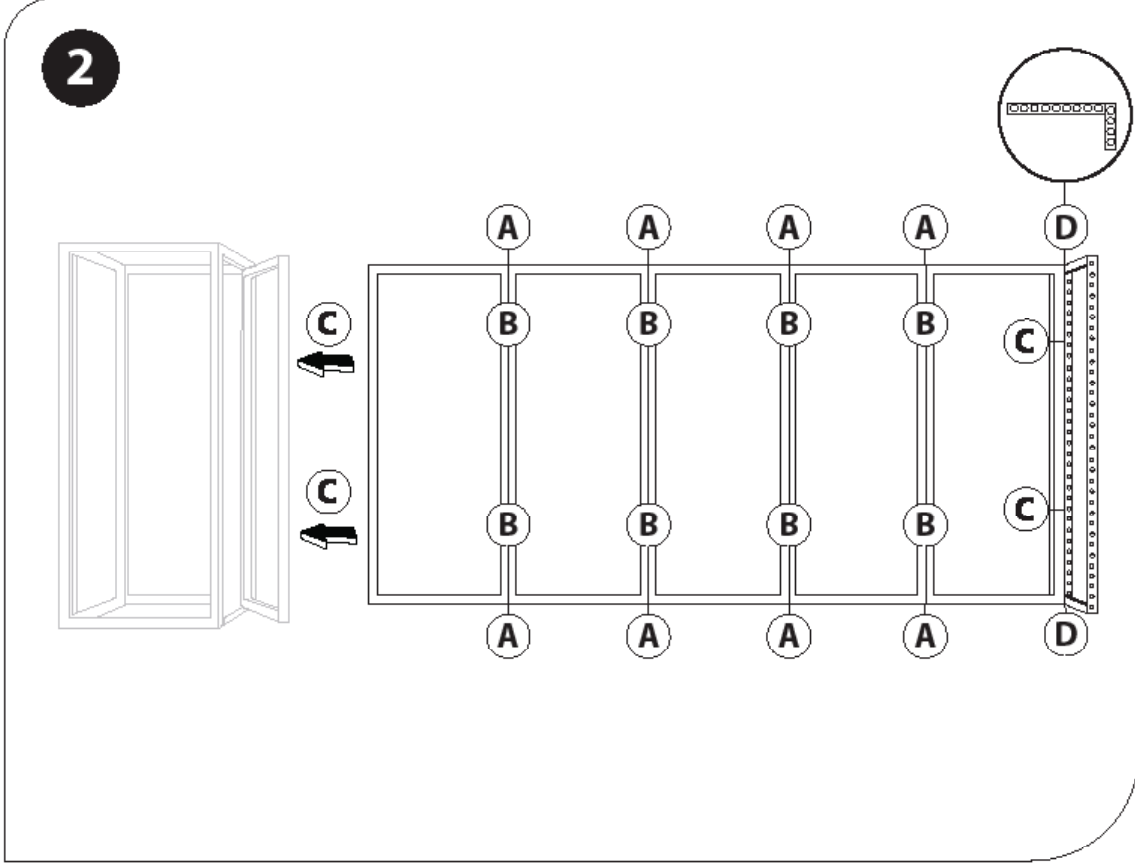

4

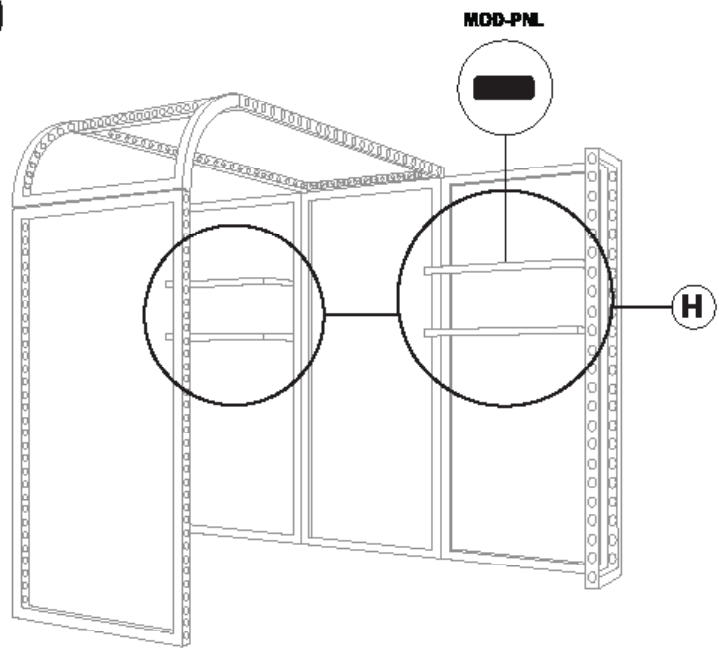

Slide panels onto shelf brackets. NO DRILLING REQUIRED.

Cover Profiles

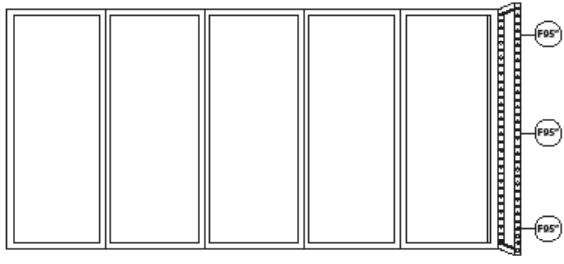
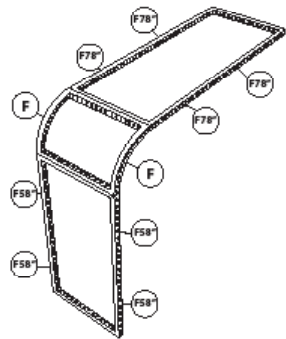
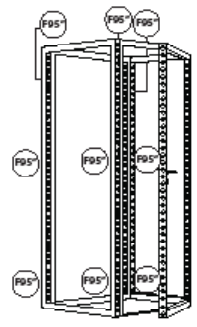

Snap in clip connectors at each designated point and then reference the measurement and install the cover profile.
*Overhead view - clip connectors/cover profiles to back side of configuration.

Graphic Install



Place graphic over the front of the frame.

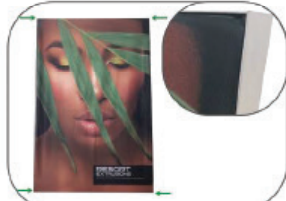

Begin inserting SEG beading at each corner.

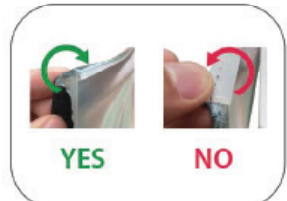

Insert the silicone beading with the fabric folded over. The silicone beading should not be exposed.

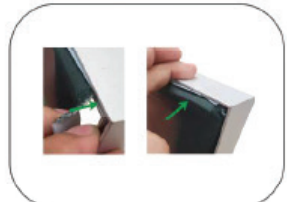

Using your fingers, push both fabric and silicone beading completely into the extrusions channel.

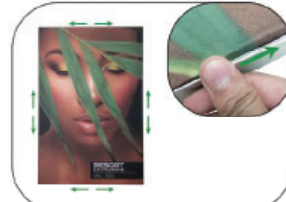

Continue to push in the remaining silicone beading on each side.

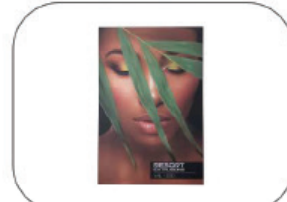

Check the perimeter of the frame for any excess beading that hasn't been pushed in. Graphic should be taut.