

**MODCO 5A - 20x20**

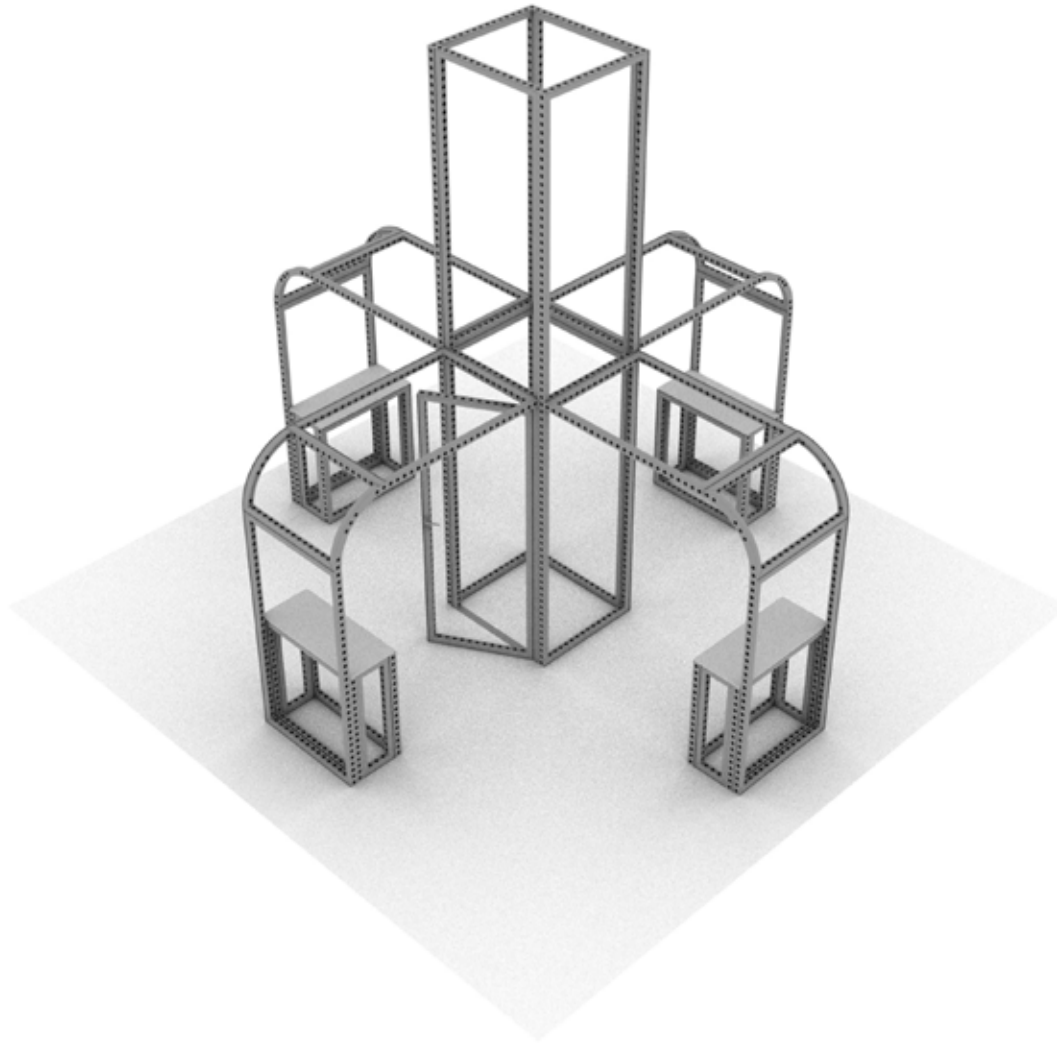

# PARTS LIST

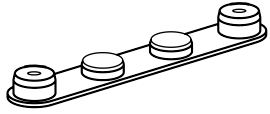

**180° Connector**  
MOD-180D-CON  
Qty.4

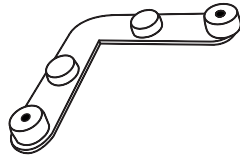

**Small 90° Connector**  
MOD-SM90D-CON  
Qty.39

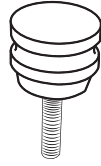

**Pin Connector**  
MOD-PC  
Qty.82

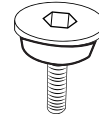

**Door Pin Connector**  
MOD-PCWP-A  
Qty.4

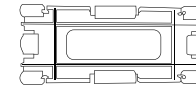

**Clip Connector**  
MOD-CC  
Qty.56

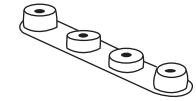

**180° Curved Connector**  
MOD-CRV-180DCL Qty.4  
MOD-CRV-180DCR Qty.4

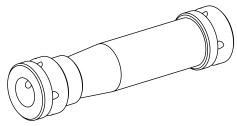

**Clamp Connector**  
MOD-CLA-CON  
Qty.22

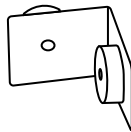

**90° Connector**  
MOD-90D-CON  
Qty.16



**1/4 Curved Cover Profile**  
MOD-CP-774  
Qty.8

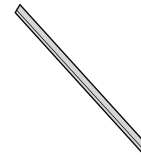

**39" Cover Profile**  
MOD-CP-3100  
Qty.16



**95" Cover Profile**  
MOD-CP-3100  
Qty.8



**992 x 1488**  
MOD-FRM-992x1488  
Qty.4

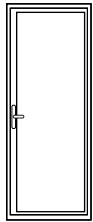

**95" Door**  
MOD-DSWL-992x2418  
Qty.1



**992 x 992**  
MOD-FRM-992x992  
Qty.8

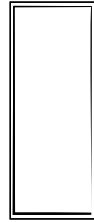

**992 x 2418**  
MOD-FRM-992x2418  
Qty.7



**310 x 992**  
MOD-FRM-310x992  
Qty.8

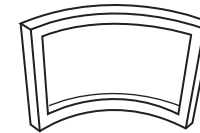

**774 x 992**  
MOD-CRVFRM-774x992  
Qty.4



**Counter**  
MOD-CTR-BM-1012x434-WHT  
Qty.4

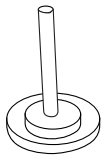

**Pin Connector for Profile Cover**  
MOD-PCWP-B  
Qty.16



**28mm Screw Nut**  
MOD-SN28MM  
Qty.16

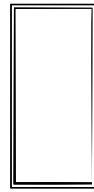

**992 x 1984**  
MOD-FRM-992x1984  
Qty.4

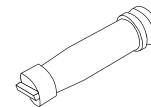

**Clamp Connector**  
MOD-DCC-180D  
Qty.2

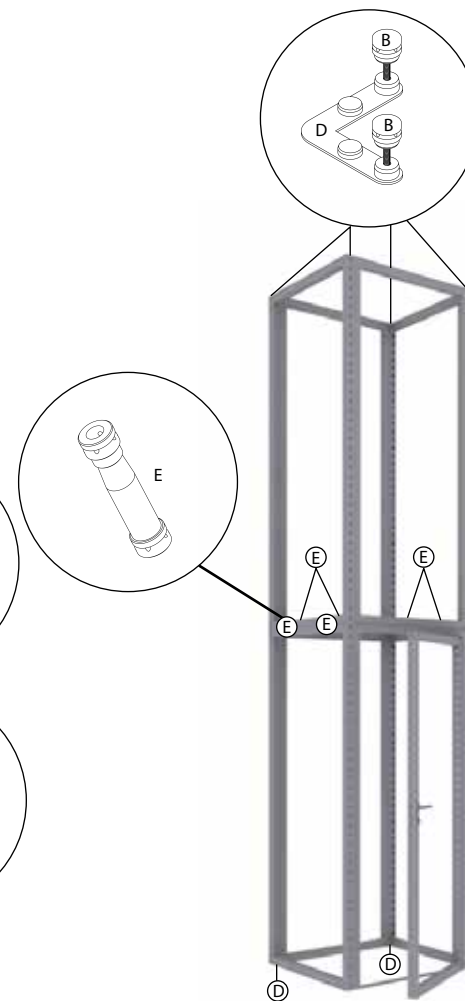
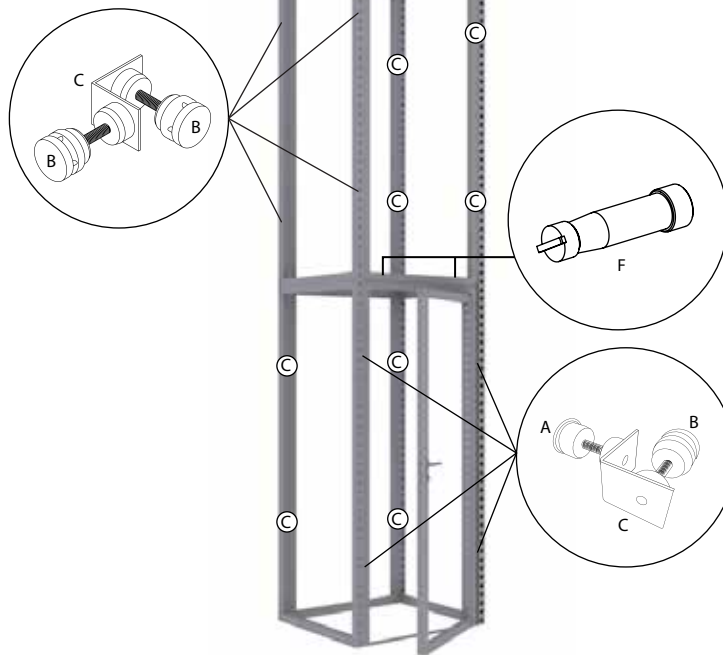

**PARTS LIST (TOWER)**

REF	QTY	PART NO.	DESCRIPTION
A	4	MOD-PCWP-A	Pin Connector for Door Jamb
B	40	MOD-PC	Pin Connector
1	7	MOD-FRM-992x2418	Straight Frame, Corner Screw Connect 992mm x 2418mm
2	1	MOD-DSWL-992x2418	Door Set w/ Lock 992mm x 2418mm
C	16	MOD-90D-CON	90° Connector
D	6	MOD-SM90D-CON	Small 90° Connector
E	6	MOD-CLA-CON	Clamp Connector
F	2	MOD-DCC-180D	Door Clamp Connector

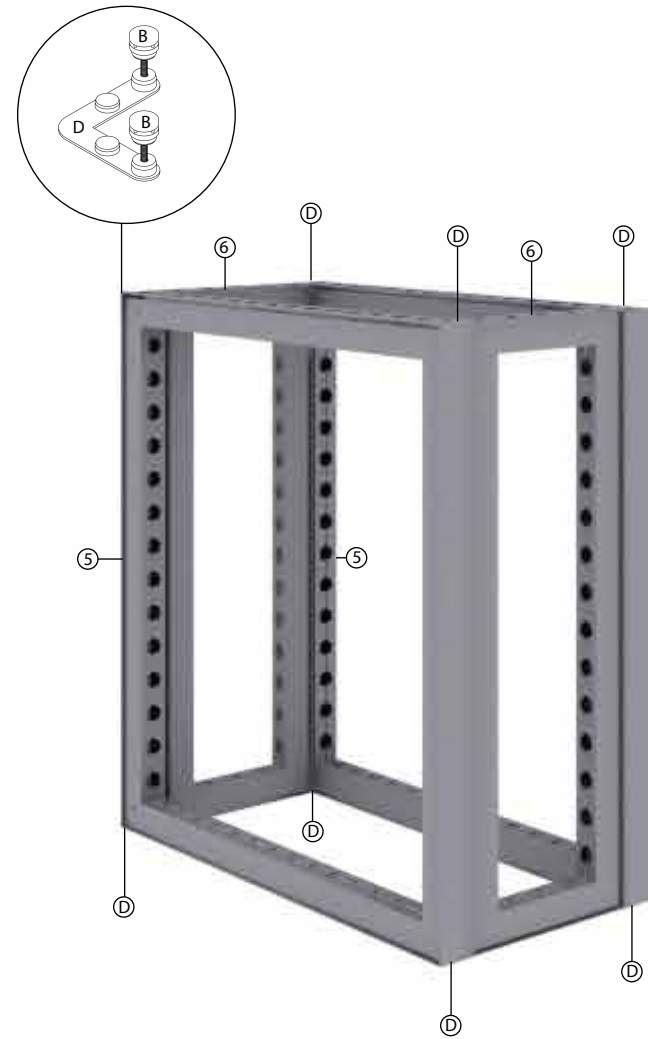
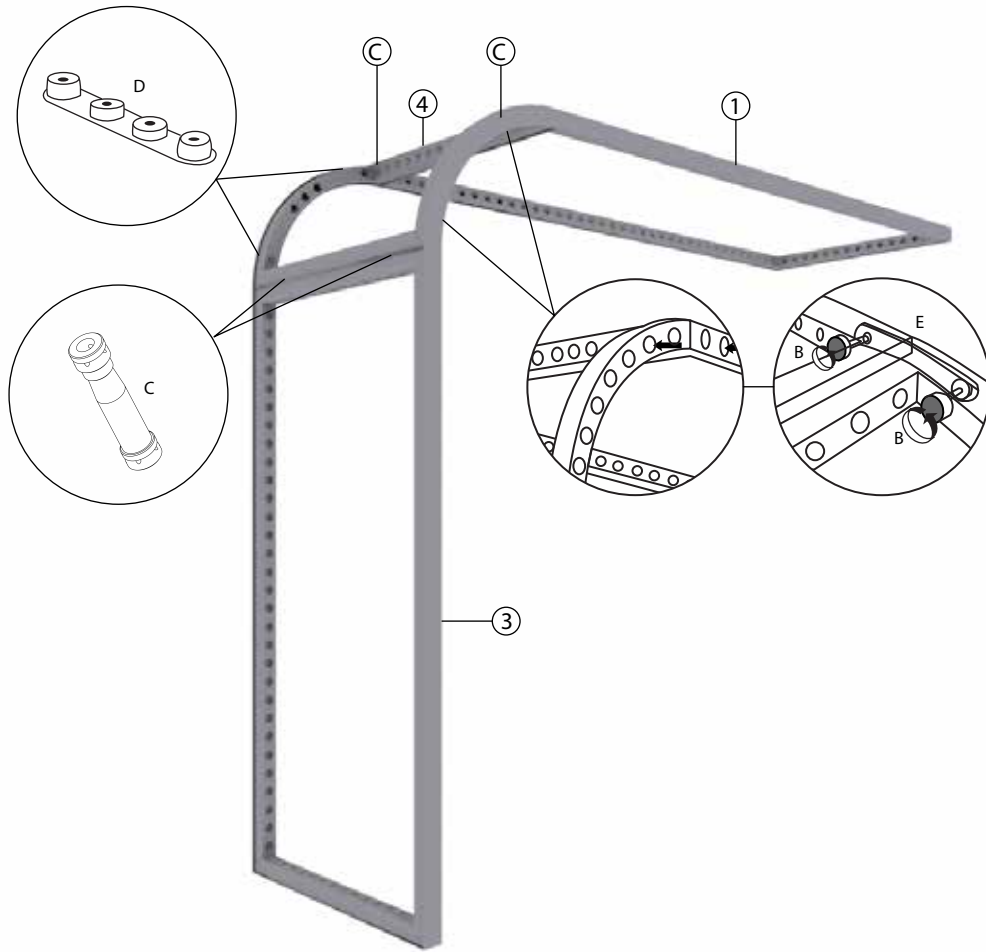

**PARTS LIST (ARCH / Qty.4 TOTAL)**

REF	QTY	PART NO.	DESCRIPTION
1	4	MOD-FRM-992x1488	Straight Frame, Corner Screw Connect 992mm x 1488mm
3	4	MOD-FRM-992x1984	Straight Frame, Corner Screw Connect 992mm x 1984mm
4	4	MOD-CRVFRM-774x992	1/4 Curved Frame, Welded 774mm x 992mm
B	32	MOD-PC	Pin Connector
C	16	MOD-CLA-CON	Clamp Connector
D	8	MOD-CRV-180DCL	Curve 180 Degree Connector (Left)
E	8	MOD-CRV-180DCR	Curve 180 Degree Connector (Right)

**PARTS LIST (COUNTER / Qty.4 TOTAL)**

REF	QTY	PART NO.	DESCRIPTION
5	8	MOD-FRM-992x992	Straight Frame, Corner Screw Connect 992mm x 992mm
6	8	MOD-FRM-310x992	Straight Frame, Corner Screw Connect 310mm x 992mm
D	32	MOD-SM90D-CON	Small 90° Connector
B	64	MOD-PC	Pin Connector

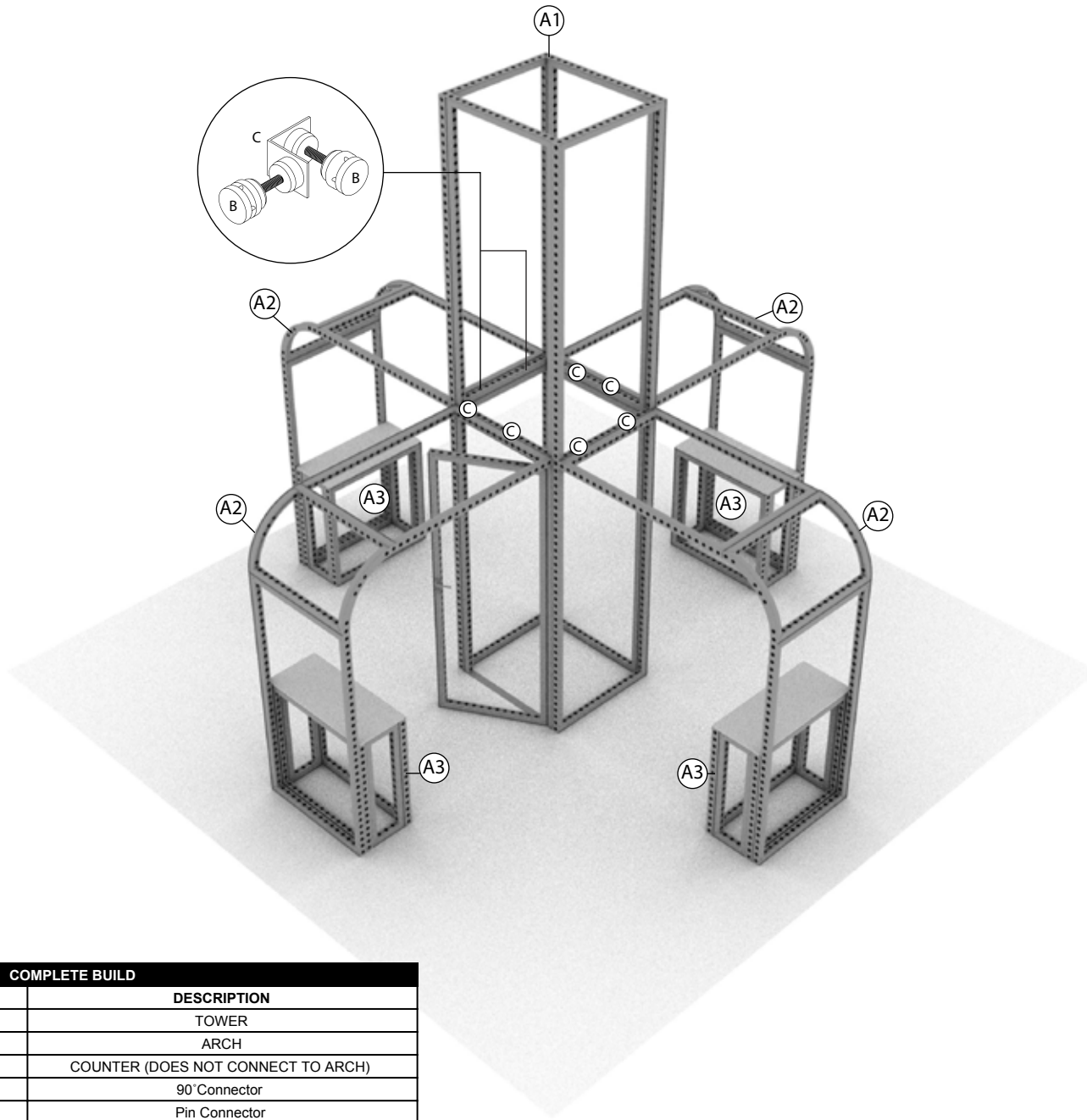

**COMPLETE BUILD**

REF	QTY	PART NO.	DESCRIPTION
A1	1	N/A	TOWER
A2	4	N/A	ARCH
A3	4	N/A	COUNTER (DOES NOT CONNECT TO ARCH)
C	8	MOD-90D-CON	90° Connector
B	16	MOD-PC	Pin Connector

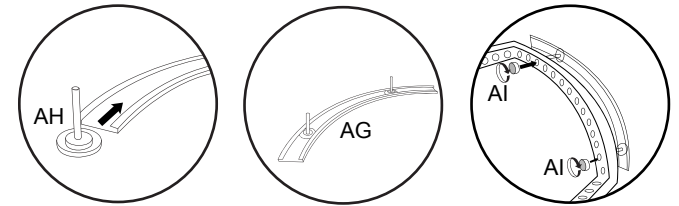
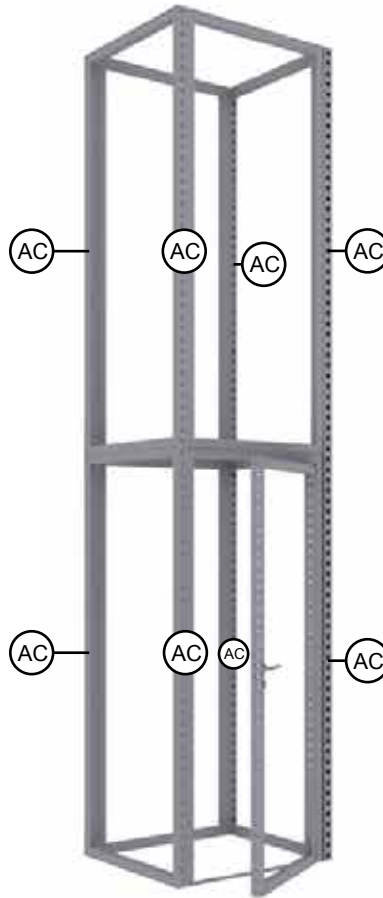
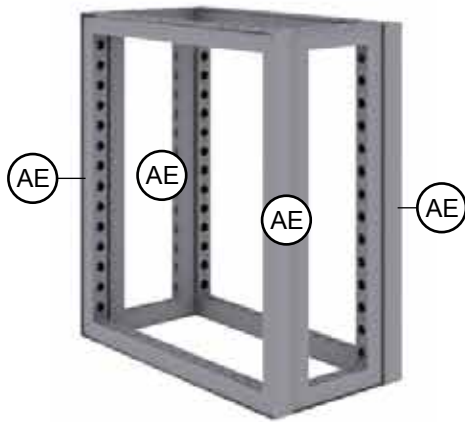
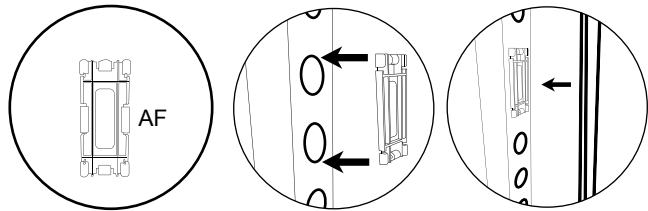

COVER PROFILES			
REF	QTY	PART NO.	DESCRIPTION
AC	8	MOD-CP-992x2418	Cover Profile for Frame 992x2418. Flat Model. Anodized
AF	36	MOD-CC	Clip Connector Cover Connects Cover Profile
AE	16	MOD-CP-3100 (39")	39" Cover Profile, Bar Per 3100mm Cover Profile. Flat Model. Anodized
AE	8	MOD-CP-3100 (58.5")	58.5" Cover Profile, Bar Per 3100mm Cover Profile. Flat Model. Anodized
AG	8	MOD-CP-774	Curved Cover profile 774mm(R1/4)
AH	16	MOD-PCWP-B	Pin connector(use with profile cover)
AI	16	MOD-SN-28MM	28mm screw nut

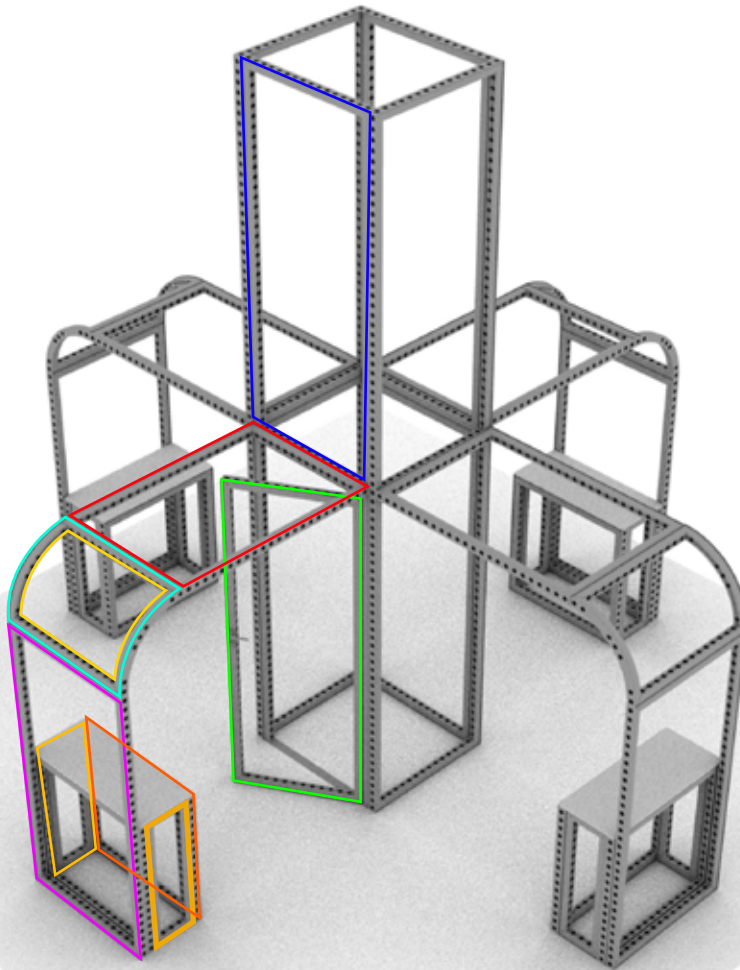

-  992 x 2418 Qty.7
-  992 x 1488 Qty.8
-  992 x 2418 DOOR Qty.1
-  774 x 992 Qty.4 OUTSIDE
-  774 x 992 Qty.4 INSIDE
-  310 x 992 Qty.8
-  992 x 992 Qty.4
-  992 x 1984 Qty.8

## Graphic Install



Place graphic over the front of the frame.



Begin inserting SEG beading at each corner.

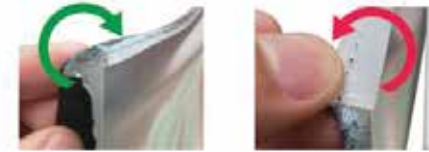

YES

NO

Insert the silicone beading with the fabric folded over. The silicone beading should not be exposed.

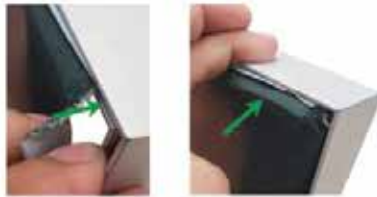

Using your fingers, push both fabric and silicone beading completely into the extrusions channel.



Continue to push in the remaining silicone beading on each side.



Check the perimeter of the frame for any excess beading that hasn't been pushed in. Graphic should be taut.