

MODCO 10 - 20 x 10

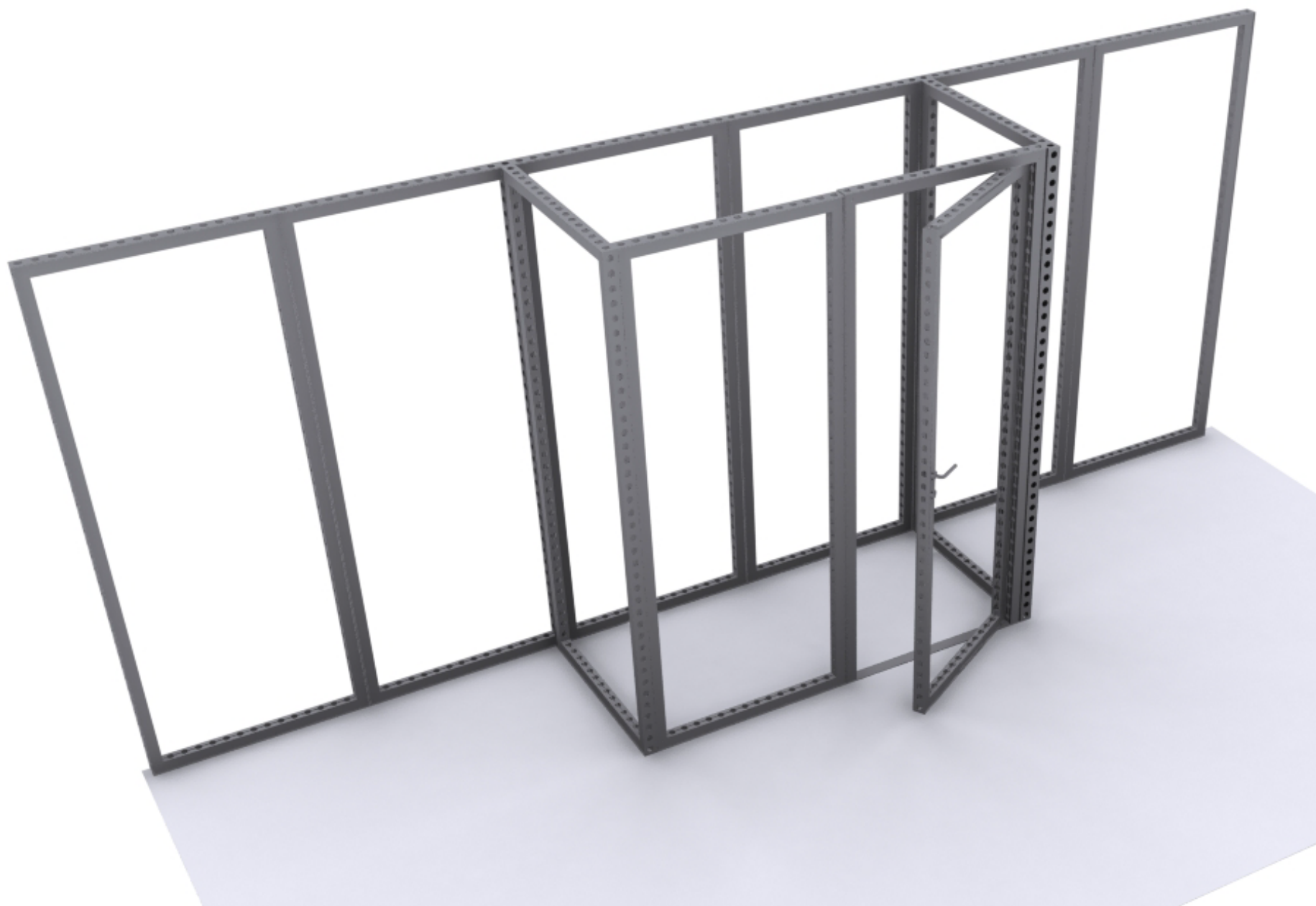

MODCO 10 - 20 x 10

- Use REF column to reference parts.
Part 1 of 2

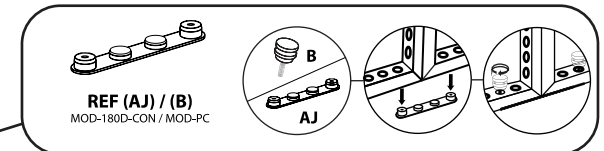
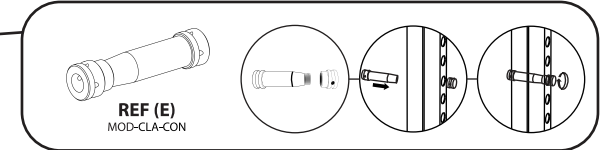
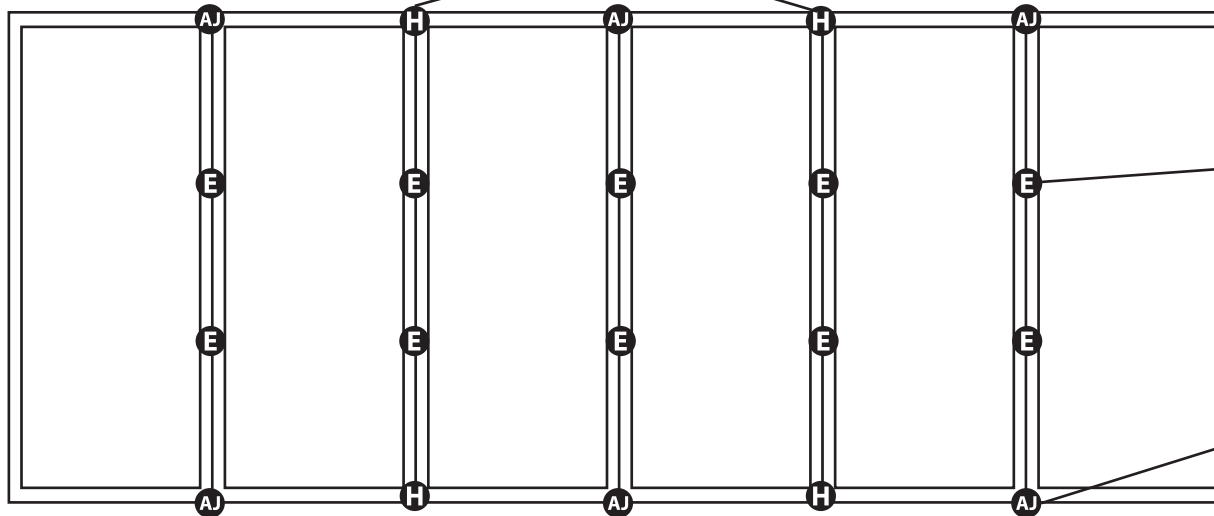
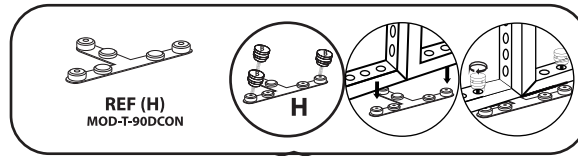
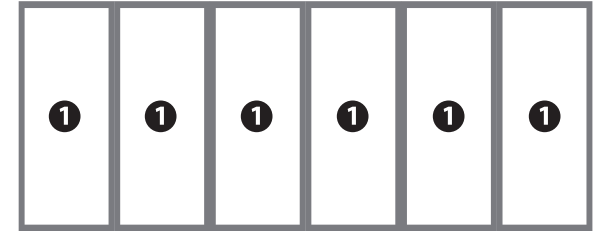

PARTS LIST (CLOSET BACKWALL)			
REF	QTY	PART NO.	DESCRIPTION
1	9	MOD-FRM-992x2418	Straight Frame, Corner Screw Connect 992mm x 2418mm
2	1	MOD-DSWL-992x2418	Door Set w/ Lock 992mm x 2418mm
A	4	MOD-PCWP-A	Pin Connector for Door Jamb
B	36	MOD-PC	Pin Connector
C	4	MOD-90D-CON	90° Connector
D	3	MOD-SM90D-CON	90° Connector
E	12	MOD-CLA-CON	Clamp Connector
H	4	MOD-T-90DCON	T Shape 3 Way 90 Degree Connector Used per Set of 2pcs
AJ	7	MOD-180D-CON	180 Degree Connector
AA	2	MOD-DCC-180D	Door Clamp Connector, 180 Degrees (Connect to Wall Frame)

MODCO 10 - 20 x 10

- Use REF column to reference parts.
Part 2 of 2

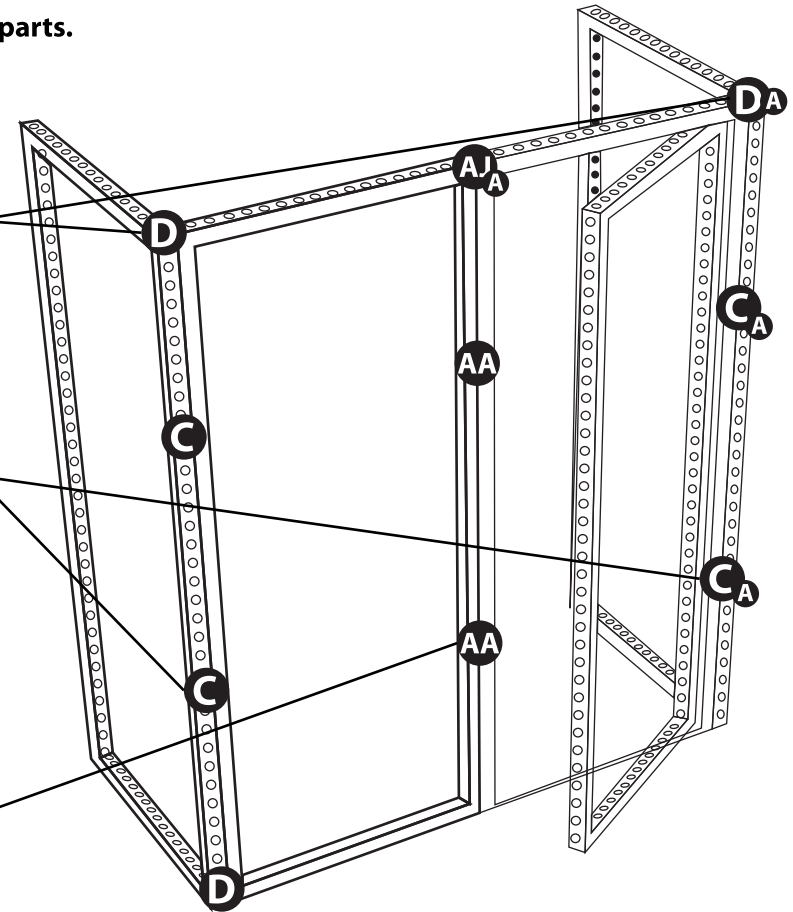
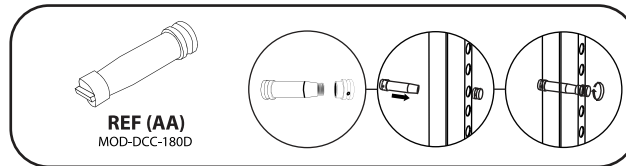
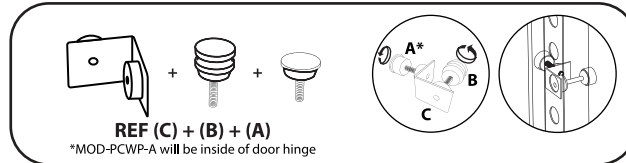
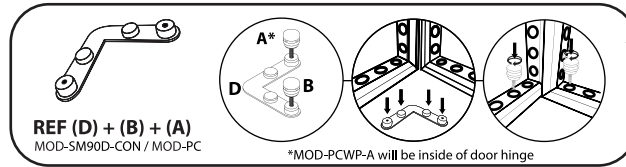

PARTS LIST (CLOSET BACKWALL)

REF	QTY	PART NO.	DESCRIPTION
1	9	MOD-FRM-992x2418	Straight Frame, Corner Screw Connect 992mm x 2418mm
2	1	MOD-DSWL-992x2418	Door Set w/ Lock 992mm x 2418mm
A	4	MOD-PCWP-A	Pin Connector for Door Jamb
B	36	MOD-PC	Pin Connector
C	4	MOD-90D-CON	90° Connector
D	3	MOD-SM90D-CON	90° Connector
E	12	MOD-CLA-CON	Clamp Connector
H	4	MOD-T-90DCON	T Shape 3 Way 90 Degree Connector Used per Set of 2pcs
AJ	7	MOD-180D-CON	180 Degree Connector
AA	2	MOD-DCC-180D	Door Clamp Connector, 180 Degrees (Connect to Wall Frame)

MODCO 10 - 20 x 10

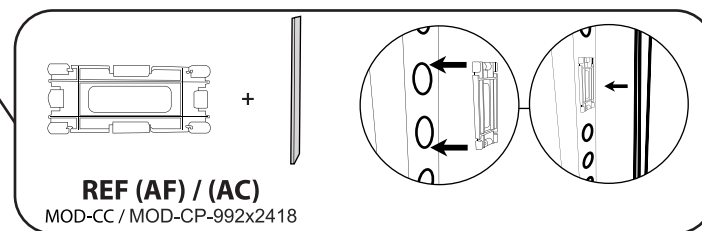
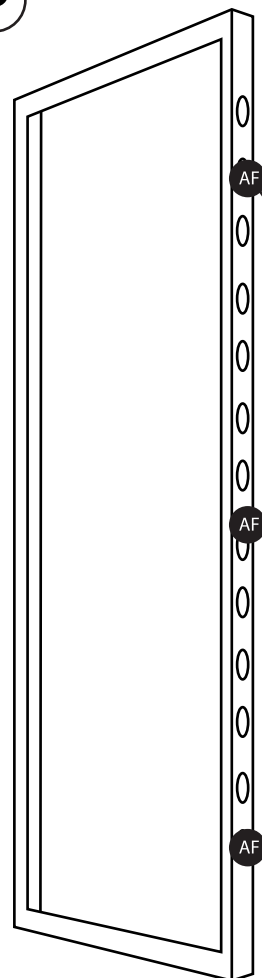

COVER PROFILES & ACCESSORIES

REF	QTY	PART NO.	DESCRIPTION
AC	4	MOD-CP-992x2418	Cover Profile for Frame 992x2418. Flat Model. Anodized
AF	12	MOD-CC	Clip Connector Cover Connects Cover Profile
AL	40	MOD-FP	Modco Frame Protector
	1	MOD-SKID	Wooden skid of L 104", W 40", H 7.5" made in Mexico

GRAPHIC INSTALL



Place graphic over the front of the frame.



Begin inserting SEG beading at each corner.



YES

NO

Insert the silicone beading with the fabric folded over. The silicone beading should not be exposed.

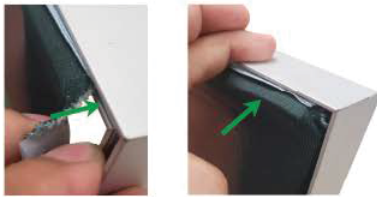

Using your fingers, push both fabric and silicone beading completely into the extrusions channel.

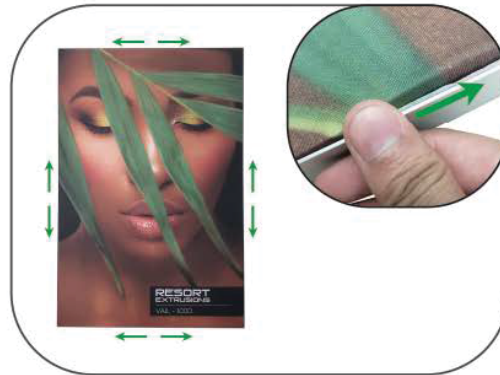

Continue to push in the remaining silicone beading on each side.



Check the perimeter of the frame for any excess beading that hasn't been pushed in. Graphic should be taut.