

# Formulate Master 5ft Dynamic Backlit Display

## FMLT-DYCL-W55-01

The Formulate® 5' Dynamic Backlit Display adds visual intrigue to any event by coupling programmed LED light curtains with an aluminum tube frame and captivating fabric graphics. Assembly is simple with light curtains that easily hook into the top and bottom of the frame and zipper pillowcase fabric graphics. The light pattern and timing is customized to bring the display to life. Stock animations are also an option.

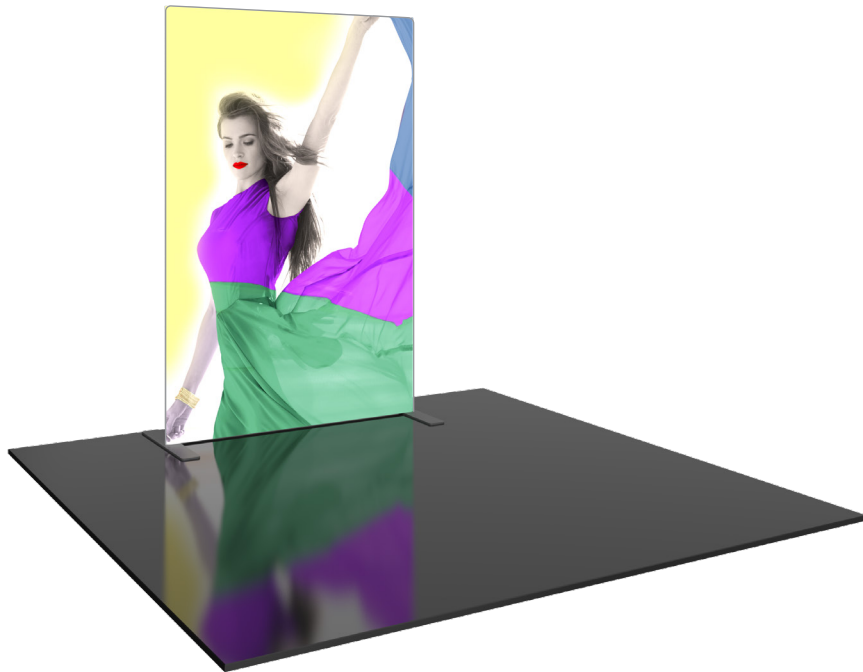

This product may include the following materials for recycle: aluminum, select wood, fabric, cardboard, paper, steel, and plastics.

We are continually improving and modifying our product range and reserve the right to vary the specifications without prior notice. All dimensions and weights quoted are approximate and we accept no responsibility for variance. E&OE. See Graphic Templates for graphic bleed specifications.

## features and benefits:

- State-of-the-art 50mm aluminum tube frame with bungee and snap-button assembly
- Dynamic LED light curtains easily attach to the frame at the top and bottom
- Single sided pillowcase fabric graphic is printed on backlit textile and includes an opaque backer
- Custom or standard animation options available
- Kit includes: one frame, one single sided dye-sublimated zipper pillowcase graphic, two light curtains, one transformer, one controller and one wheeled OCE molded storage case
- Easy to store and ship
- Lifetime frame warranty against manufacturer defects
- 90 day electronic component warranty

## dimensions:

### Hardware

### Graphic

Assembled unit:  
63.71" w x 92" h x 25.59" d  
1618mm(w) x 2337mm(h) x 649mm(d)

Refer to related graphic template for more information.

Approximate weight without case:  
48 lbs / 22 kg

One year warranty

Visit:  
<https://www.theexhibitorshandbook.com/download-graphic-templates>

### Shipping

## additional information:

Packing case(s):  
1 OCE

Graphic material:  
Dye-sublimation zipper pillowcase fabric -  
Backlit textile with opaque backer

Shipping dimensions:  
OCE: Expandable case length (l) may vary  
40"-66" l x 18" h x 18" d  
1016mm-1677mm(l) x 458mm(h) x 458mm(d)

Transformer Power Requirements:

Watts:	Amps:	Volts:
600W	12A	115-230V

Approximate total shipping weight:  
76 lbs / 35 kg



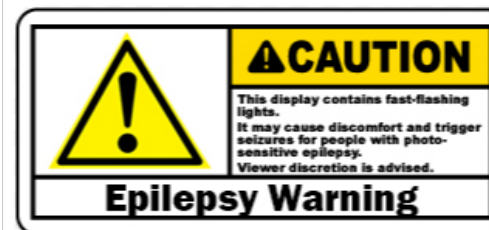

When included in a larger order, a different packaging solution will be provided to accommodate all contents of the order. Individual packaging may no longer be provided.



# Standard Animation Options

## DYN-STOCK-DESIGN-

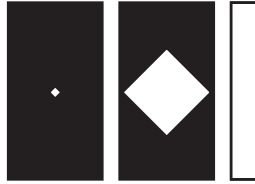
Applies to all sizes

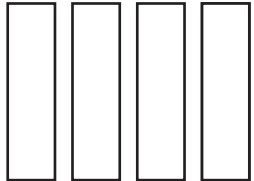
<p>Cascade <b>CASCADE</b></p> 	<p>Lift Off <b>LIFTOFF</b></p> 	<p>Diamond <b>DIAMOND</b></p> 	<p>Firework <b>FIREWORK</b></p> 
<p>All Lights <b>ALL-LIGHT-ON</b></p> 			

Applies to 8' / 10' sizes only

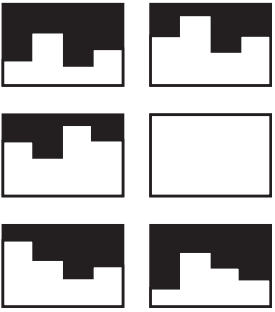
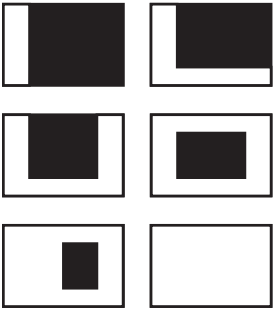
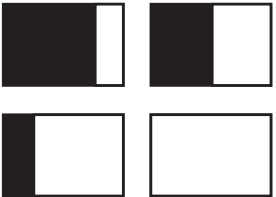
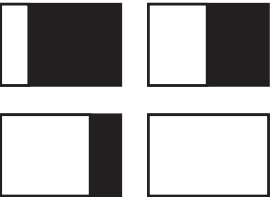
<p>Noise <b>NOISE</b></p> 	<p>Snake <b>SNAKE</b></p> 	<p>Wave Left <b>WAVE-L</b></p> 	<p>Wave Right <b>WAVE-R</b></p> 
---	---	--	---

# Included In Your Kit

Tools, Components, & Connectors

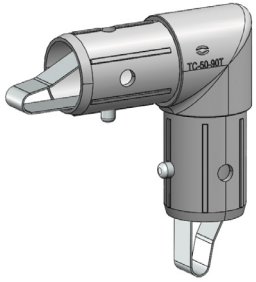

TC-50-90T x2

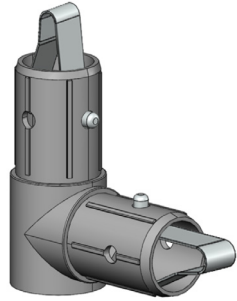

TC-50-90B x2

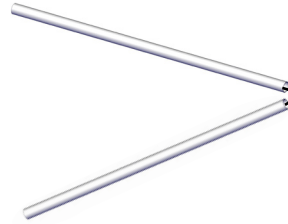

FMLT-DYCL-WS5-01-SIDE x2



FMLT-DYCL-WS5-01-T2 x2

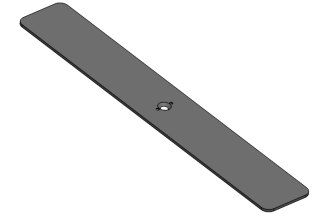

LN114-S2-650 x2



LED-DYCL-710MM x2



LED-CURTAIN-TRANS-2 x1



LED-DYCL-CONTROLLER x1



DYCL-SD-CARD-8GB x1



LED-DYCL-CABLES x1



HEX-KEY-5MM x1



ES30-90-SCRW x2



OCE x1

Graphics

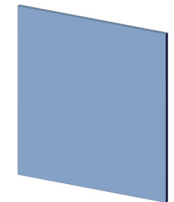

FMLT-DYCL-WS5-01-G x1

# Exploded View

FMLT-DYCL-WS5-01

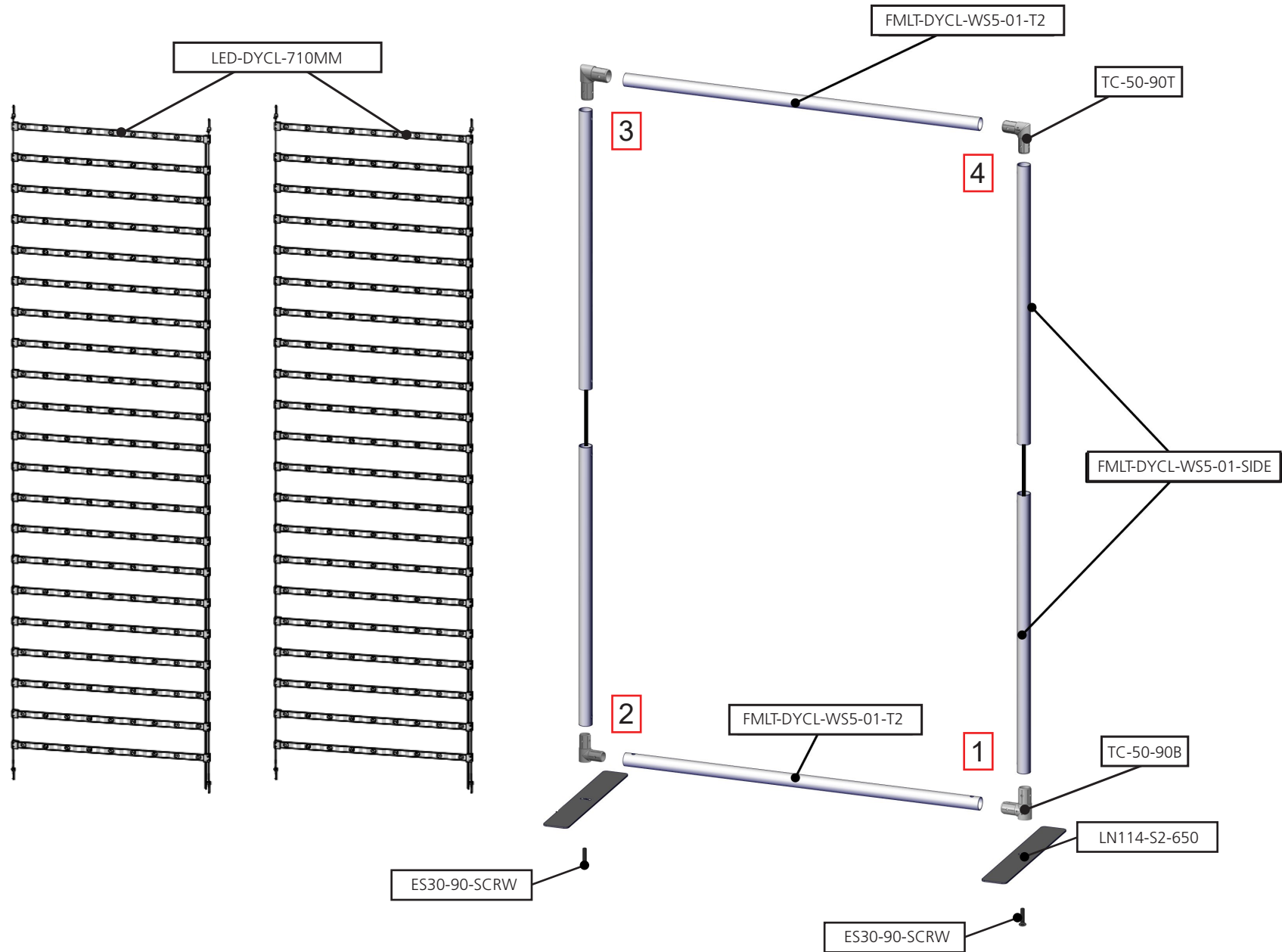

# Connection Methods

## Connection Method 1: TC-50-90T

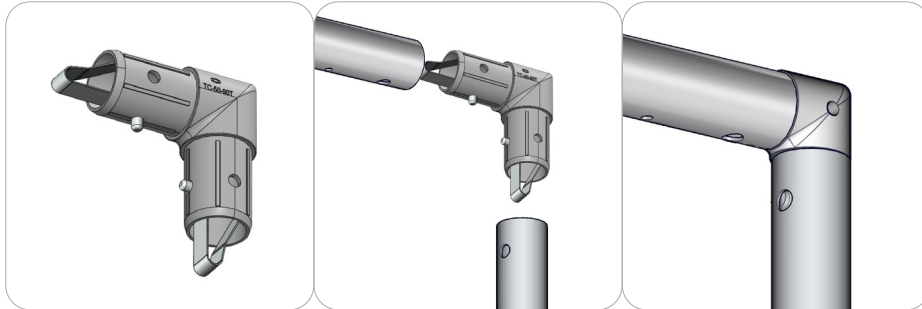

Take the plastic connector and make sure the snap buttons are in proper position for the frame tube holes. Simply press the snap button with your thumb and carefully slide the tube onto the connector. The snap button should pop through. Some twisting may be necessary to assure the snap button has popped all the way through the tube hole. Do not force the connection and be careful with the tube edges, they may be sharp.

## Connection Method 2: TC-50-90B

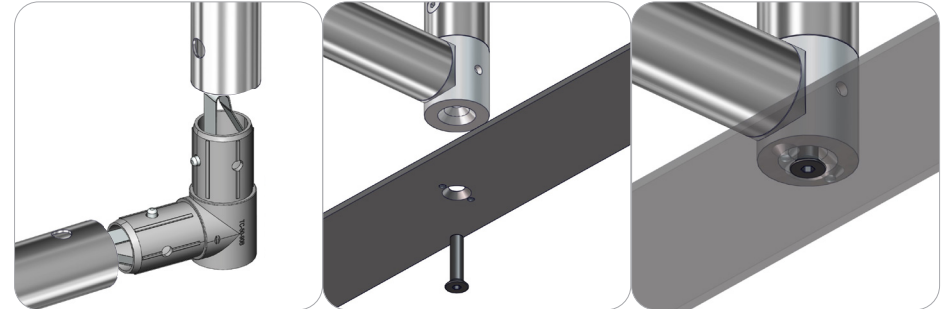

Take the plastic connector and make sure the snap buttons are in proper position for the frame tube holes. Simply press the snap button with your thumb and carefully slide the tube onto the connector. The snap button should pop through. Some twisting may be necessary to assure the snap button has popped all the way through the tube hole. Do not force the connection and be careful with the tube edges, they may be sharp.

## Connection Method 3: SNAP BUTTONS



For snap button connections, locate the snap button on the connector or swage tube. Locate the hole on the corresponding tube. Press the snap button with your thumb and slide the tube and connector together so that the snap button snaps fully into the lock hole. To disassemble, press the snap button and pull apart.

# Frame Assembly

## Step by Step

### Step 1.

Unzip and remove all tubes from the bag. Assemble the bungee connected tubes using the push buttons. See Connection Method 3 for more details.

See Connection Method 1 for the top of the frame, and Connection Method 2 for the bottom of the frame.

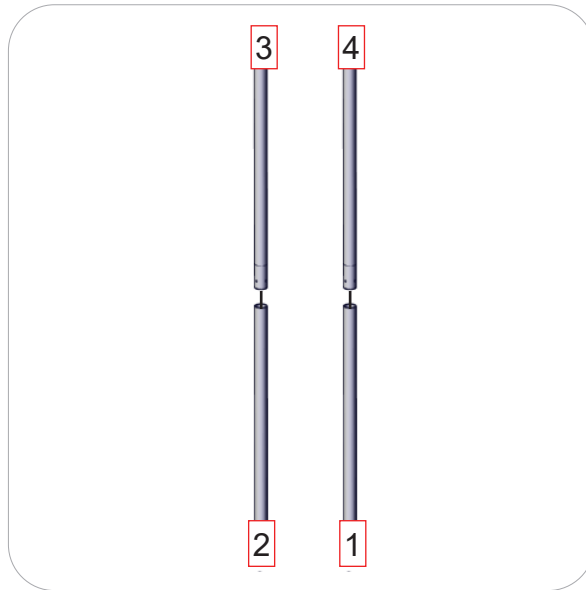
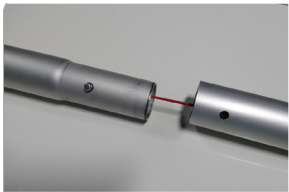

### Step 2.

Match the labeled numbers at the ends of the previously assembled tubes and combine to assemble the frame.

See Connection Method 1 for the top of the frame, and Connection Method 2 for the bottom of the frame.

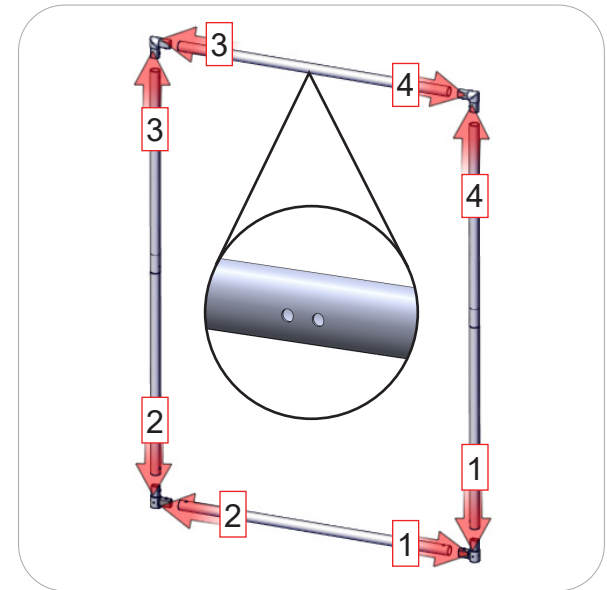

### Step 3.

Attach the feet by removing the bolt from the bottom of the upright tubes, placing the foot against the frame, and inserting the bolt through the foot and into the frame so the bolt head sits in the countersunk hole and is flush with the foot.

Hand tighten and lay the feet so they sit flat against the floor on their side.

Reference Connection Method 2 for more details.

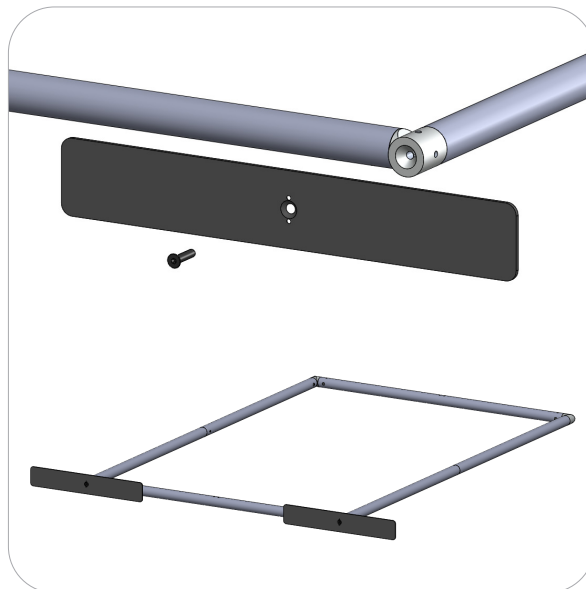

# Light Curtain Attachment

## Step by Step

### Step 4.

Remove one of the light curtains from its box and bring it to the frame.

Check the plugs of the curtain; with the male end toward the top of the frame, unroll the curtain with the bulbs facing down.

Be sure to keep the padding and packaging to protect the lights during storage and shipping.



### Step 5.

Hook the light curtain clips into the two holes at the top of the frame closest to the side.

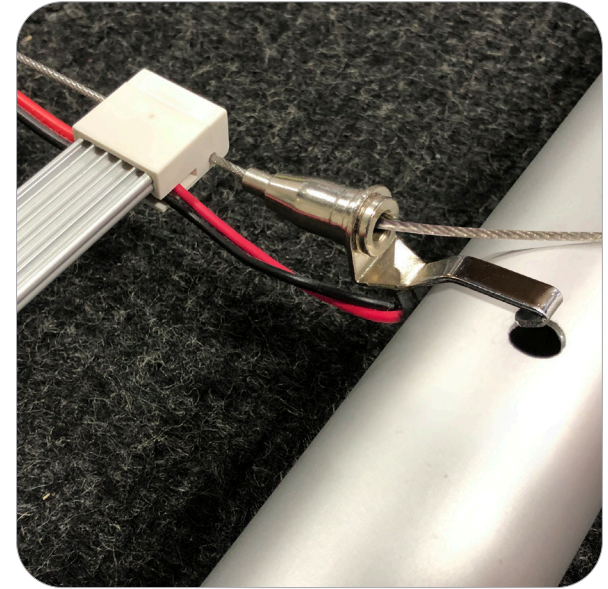

### Step 6.

Unroll the light curtain and leave the bottom loose.

Repeat Steps 4-6 until all curtains have been hooked to the top of the frame.



### Step 7.

Insert any excess cable of the light curtains into the hole of its connected hook to prevent it from pushing against the graphic.

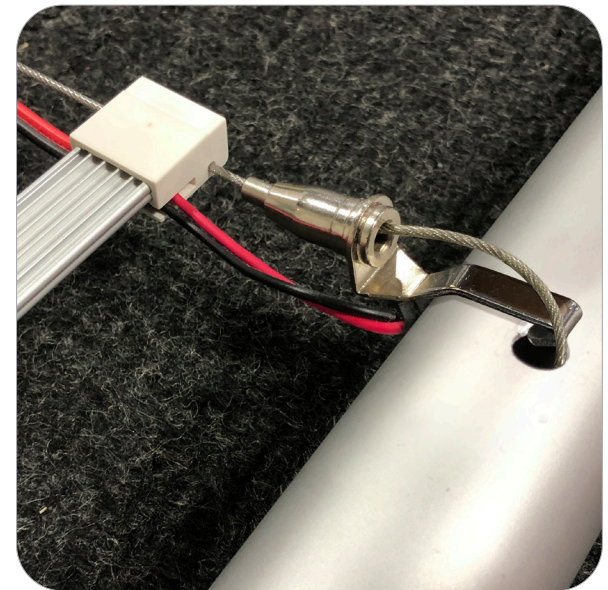

# Light Curtain/Graphic Attachment

## Step by Step

### Step 8.

Move to the bottom of the frame and insert the light hooks from the bottom of the curtains into the holes.

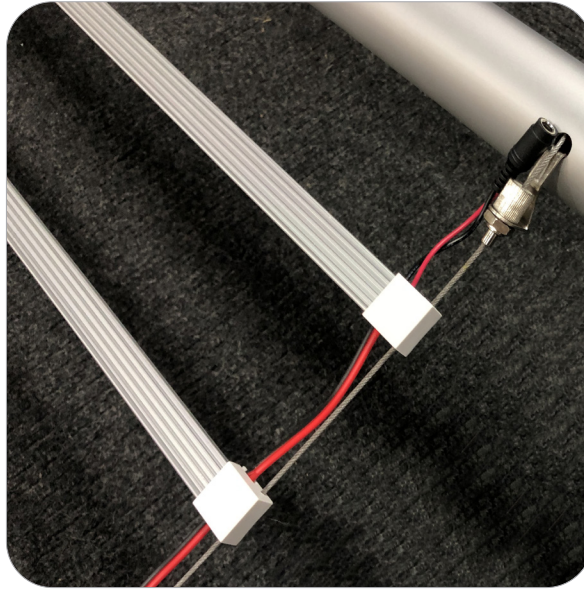

### Step 9.

Tighten the curtain light cables so that the curtain is taught with the frame and insert excess cable into the bottom hole to prevent it from pushing against the graphic.

See next page for in-depth instructions on tightening the curtain, and pages 10 and 11 for wiring the lights.



## Adjusting Light Curtain Tension

Locate the curtain light hook button.

Press down on the button releasing pressure from the curtain light cable.

While pressing down on the button pull the cable away from the curtain light until it is tight with the frame.

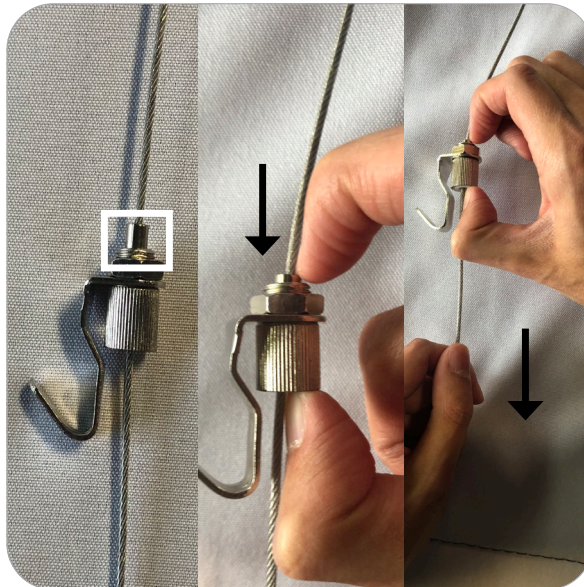



# Light Connection

## Step by Step

### Step 10.

Connect the light curtains together with the LED-DYCL-CABLES;

From the back of the frame, start at the top-right corner of the left-most curtain and connect the LED-DYCL-CABLE to the bottom-right corner of the next adjacent curtain, as shown to the right.

Then repeat, starting at the top-right of the newly bottom-connected curtain, for all remaining curtains.

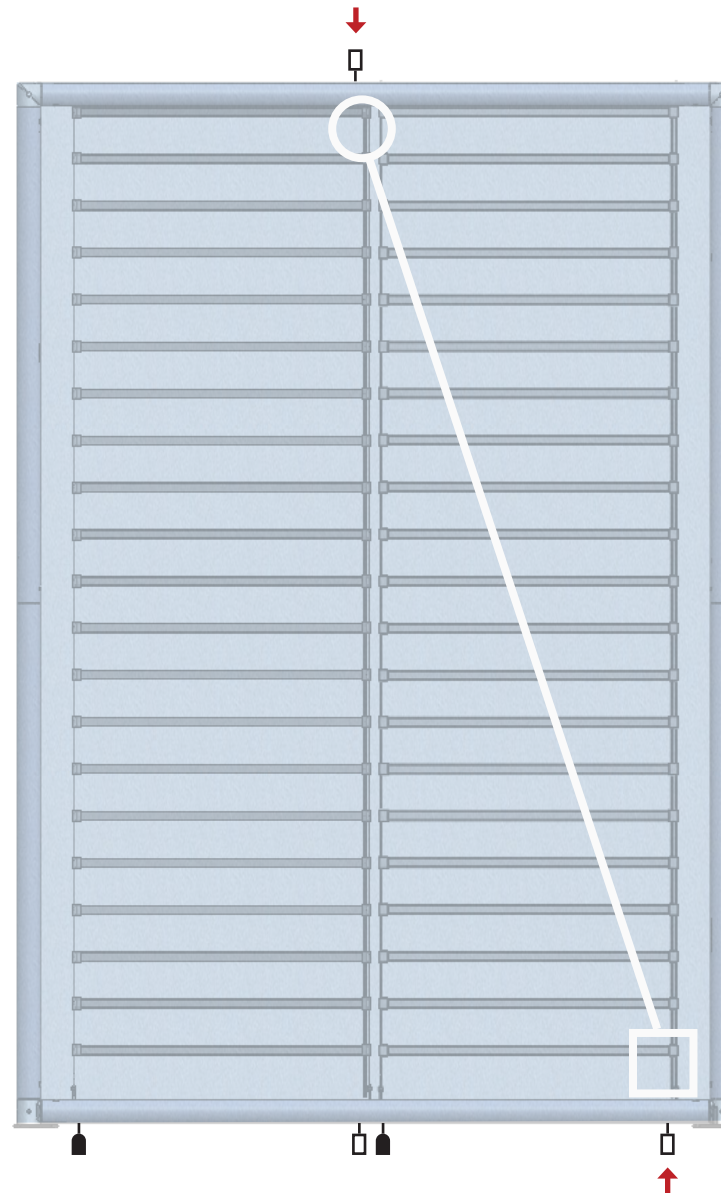
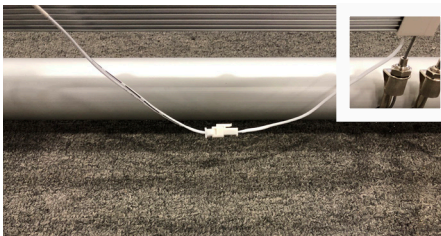

Back View

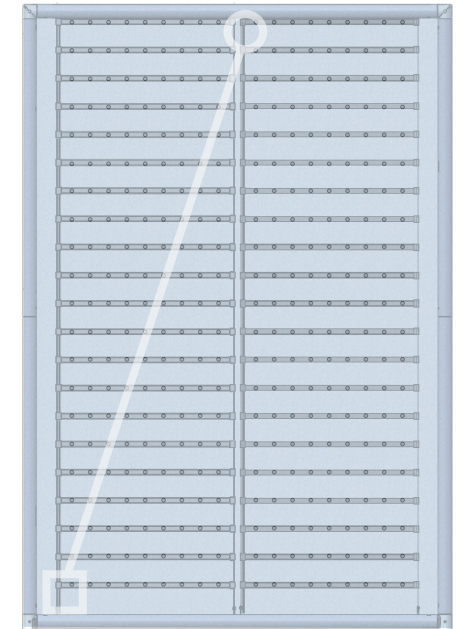

Front View

# Transformer and Controller Connection

## Step by Step

### Step 11.

Connect the light curtains to the transformers for power;

From the back of the frame, plug in the black plug of the light curtains to the transformer plugs.

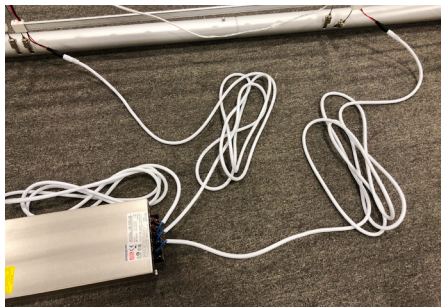

Connect the controller to a transformer for power (see image on the right);

From the back of the frame, plug in the black plug of the controller to the transformer plugs.

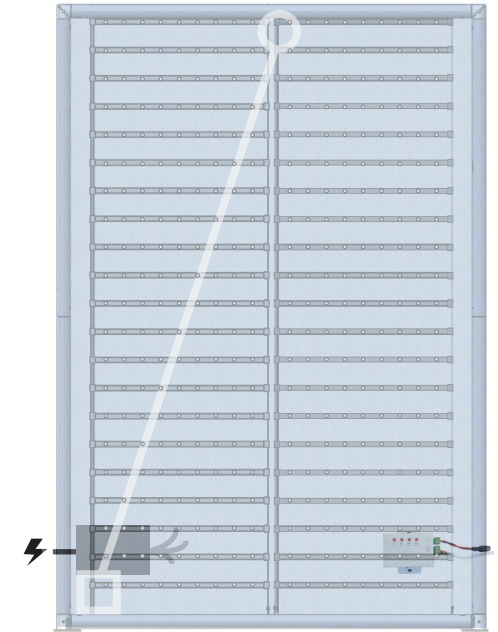
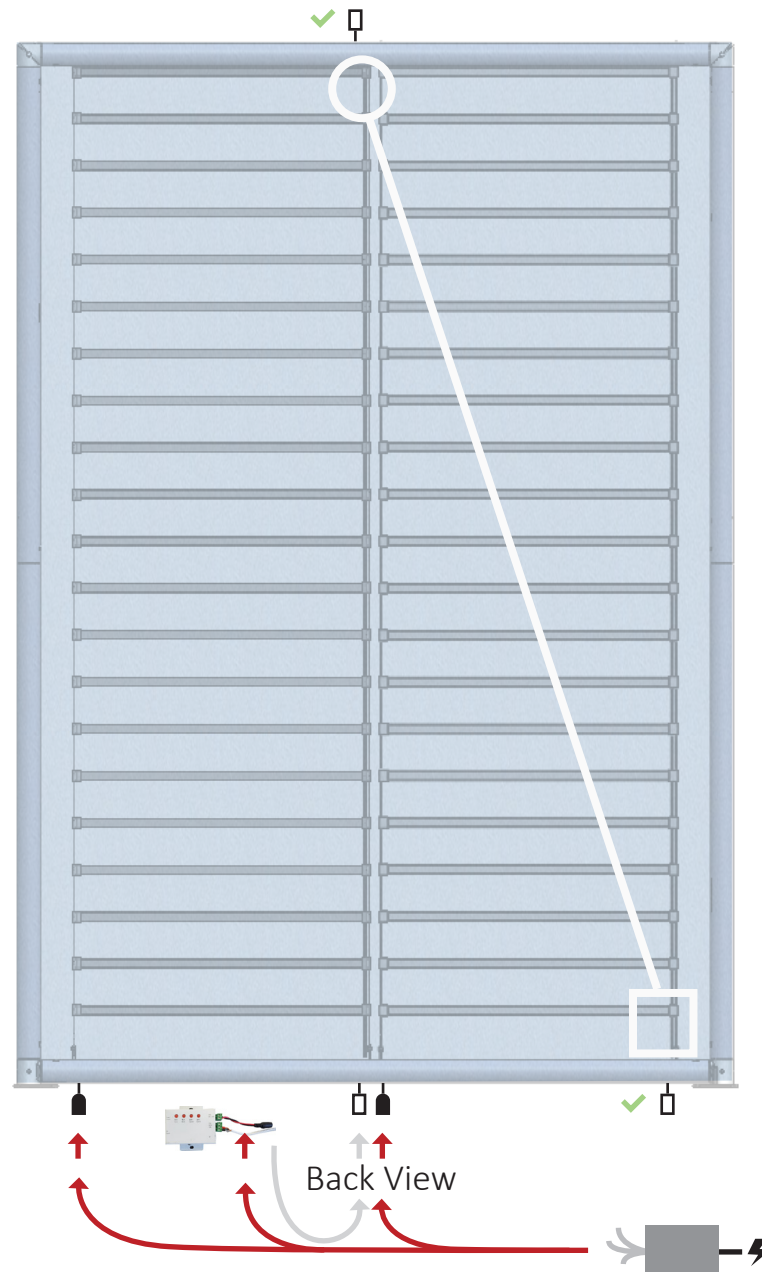

Front View

**Important:** the controller must be connected to the right-most light curtain from the front (left-most from the back) for the animation to operate correctly.

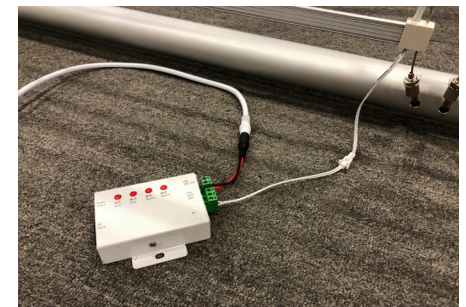

# Applying Graphic & Powering Up

## Step by Step

### Step 10.

Rotate the feet to their correct, perpendicular orientation.

With the frame still laying on the ground, pull the pillowcase graphic over the top of the frame to begin fitting.

Make sure the graphic is being installed evenly down both sides of the frame.



### Step 11.

Once the graphic has reached 1/4 to 1/2 way down the frame, you can stand the frame upright to assist in installing the graphic the rest of the way down the frame.

Roll up the padding for the lights and store in the light curtain boxes to use during dismantle.



### Step 12.

Zip the bottom of the graphic; one section for each light curtain.



### Step 13.

Plug in the transformer.

Do not cover or hinder airflow to the transformer as it needs air circulation to work properly.

Set up is complete.

Note: In the US, set the transformer to 115v; International, set it to 230v.

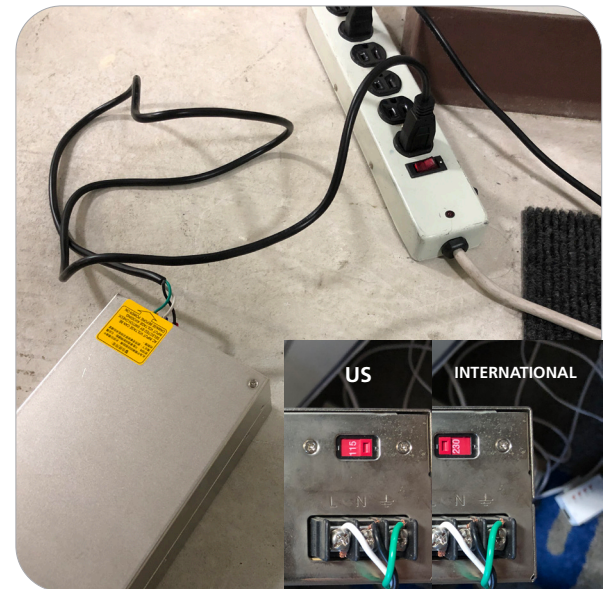

# Dynamic Curtain Light Controller Information

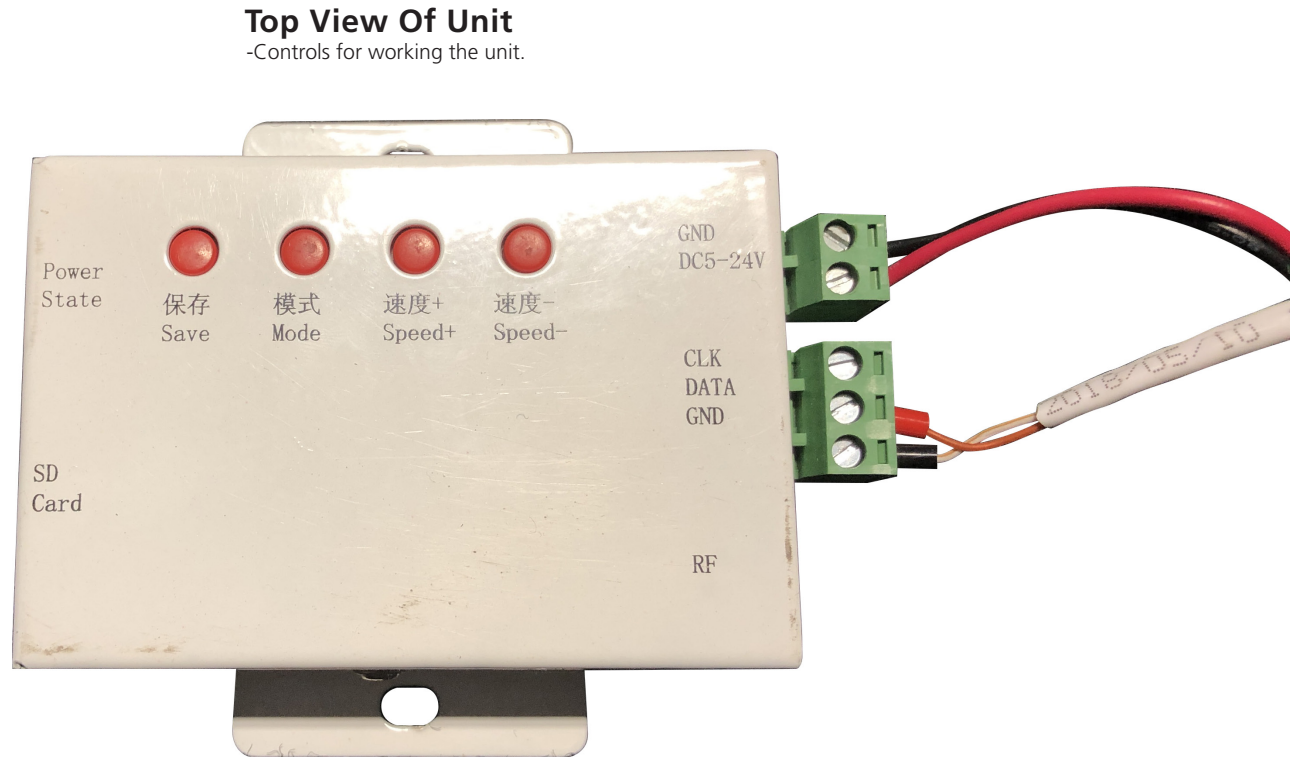
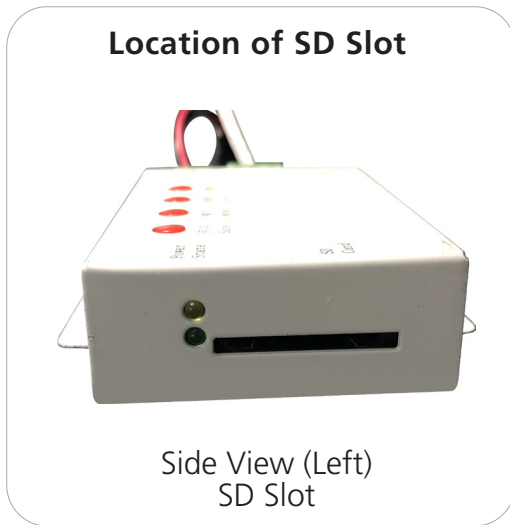

Save:  
Unused

Mode:  
Unused

Speed+:  
Increase the speed  
at which the  
animation runs

Speed-:  
Decrease the speed  
at which the  
animation runs