

Vivid Kiosk

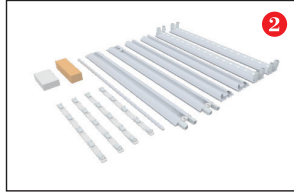

1, A big package and a small package



2, Open the small package



3-4, Install the frame according to the labels



5-6, Lucid Storage Lightbox

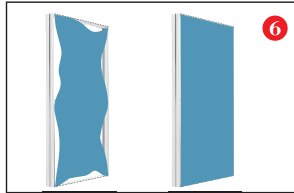

7, Part A and Part B are packed into the big package



8, Install part A according to the labels, Part A finished.

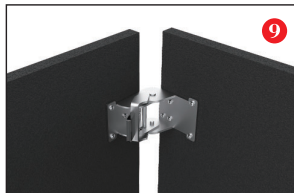

9-10, Install part B according to the labels

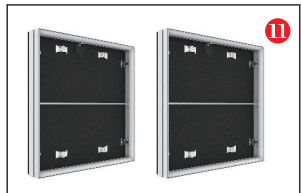

11, Part B finished

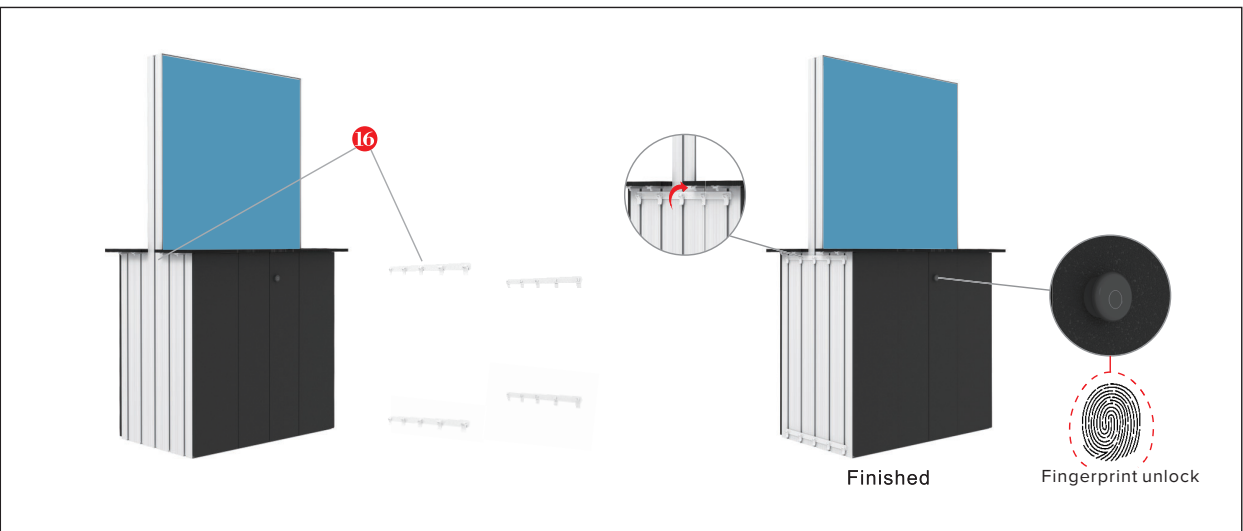
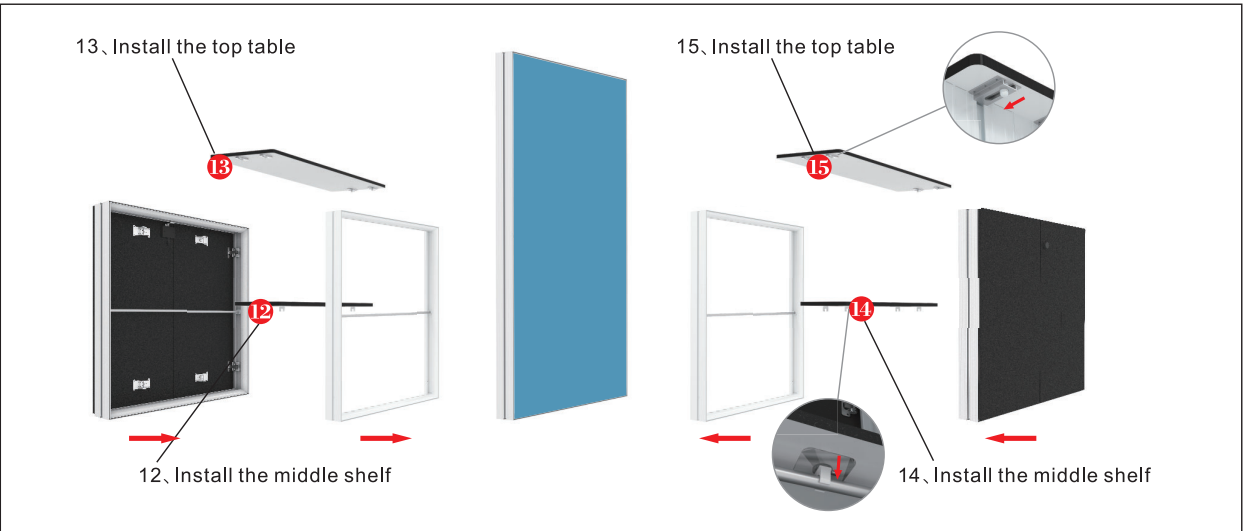

FINGERPRINT CABINET LOCK USER MANUAL

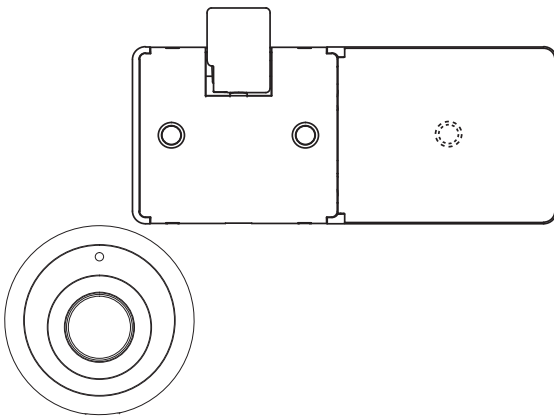

Feature

1. Biometric sensor, high sensitive and rapid responsive
2. Max 20 fingerprints to hold for multiple users
3. E-Key for emergency key and management
4. Zinc alloy panel with elegant design
5. Surface mounted, widely used in drawer, cabinet, wardrobe etc.

V000230418

Automatic Mode

1. How to add new fingerprints

- Put a registered finger on sensor, green light and latch retracts, keep holding, green light on, then remove
- Blue light, put a finger on, green light then remove
- Put the finger on, green light then remove; repeat until a long green light for 2 seconds (The fingerprint is registered)
- Blue light, add more new fingerprints

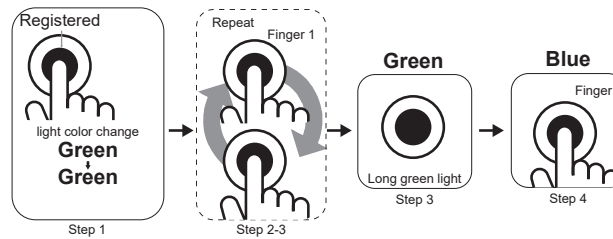

Note

- 1). Make sure add the fingerprint before using. Any finger can unlock in the factory setting
- 2) In order to keep the lock work well, to add no less than 3 fingerprints

2. How to delete fingerprints

- Put any registered on sensor, green light, holding, green light again, keep holding, green light then red light flashed, then remove
- green light for 2 seconds, all the fingerprints deleted

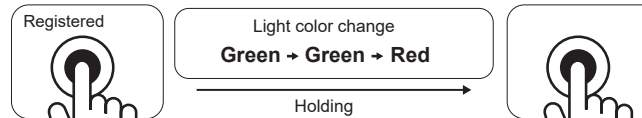

3. How to lock

- Push the door closed, door lock automatically

4. How to unlock

- Put any registered fingerprint on sensor
- Green light, unlocked
- Pull the door open

Other Function

E-Key

1. Insert E-Key
2. Put any finger on sensor, green light on, unlocked
3. Pull the door open

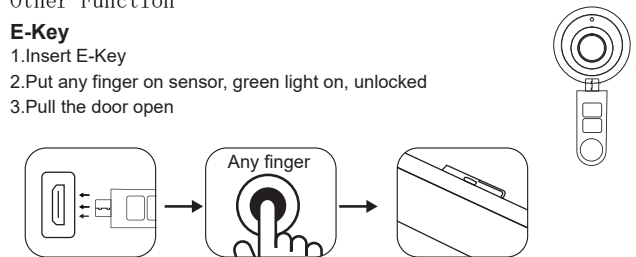

2. Low battery warning

- In case of low battery, to put on the registered fingerprint, green light flashes once, and red light flashes thrice, then a long green light, unlocked. To change the battery immediately after door open
- Note: Use 3XAAA alkaline battery, not take Carbon battery

3. Outer Power Supply

- When low battery, can connect power bank or mobile plug for outer power supply
- After unlocked, change the battery immediately

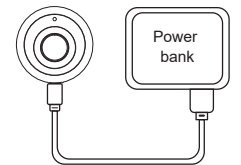

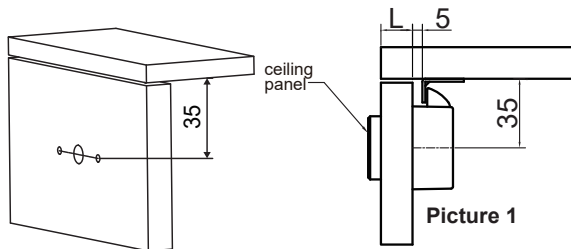

Installation Instructions

1. Put the installation drawing on the door, approx. 35mm between the door frame and center hole (Picture 1), then drill the hole

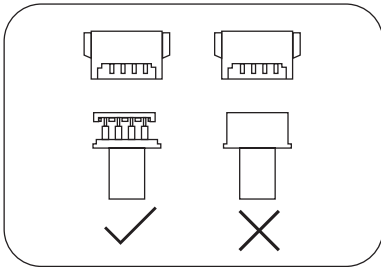

wire connection



	Door Thickness (mm)	Screw
	14mm~16mm	(M4*20) X 2
	16mm~18mm	(M4*22) X 2
	19mm~21mm	(M4*25) X 2

2. Connect one end of the panel connection line through the middle round hole with the lock box, first use two cross pan head screws M4*22 to fix the panel on the door panel, organize the connection line to avoid being pressed, then use two cross countersunk head wood screws 3.5*30 and one cross countersunk head wood screw 3.5*16 to fix the lock box on the door panel.

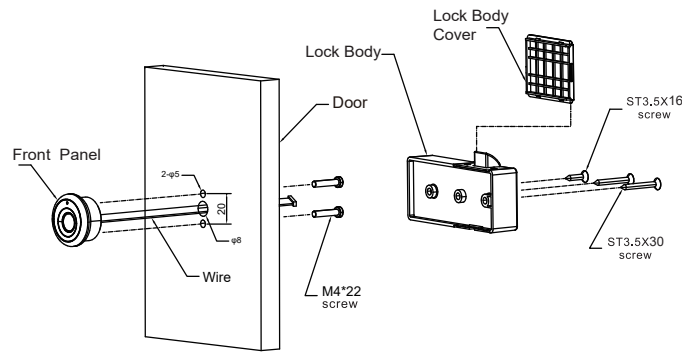

Picture 2

3. Fix the striking plate by screw ST3.5X12 (Make sure latch works well)

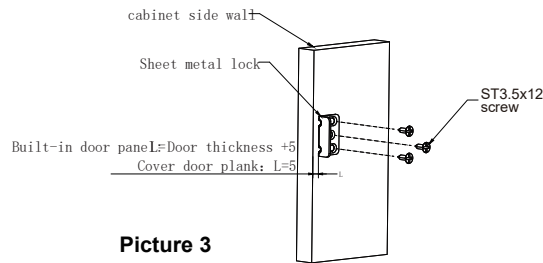

Picture 3

COMPONENT

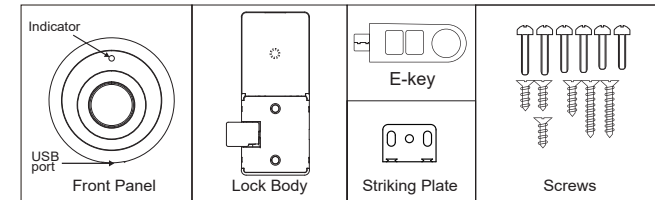

INSTALLATION DRAWING

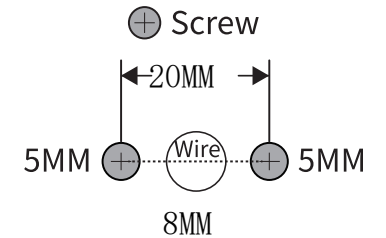

Follow the drawing to drill the hole